

JLR-7600/7900

GPS NAVIGATOR

**INSTRUCTION
MANUAL**

Foreword

Thank you for purchasing the JRC GPS Navigator JLR-7900/7600.



This equipment is a high-performance navigation equipment consisting of a DGPS/GPS sensor and navigator, can retrieve the position data using the DGPS/GPS sensor to display various navigation information on the display.

- Thoroughly read this instruction manual before operating the equipment.
- Keep this manual nearby the equipment to allow ready access to it if necessary. It may provide valuable information on how to deal with a given situation that may arise during the operation.

Before Commencing the Operation

Symbols

Several symbols are used in this manual to ensure safety and proper operation of the equipment and to avoid possible human injury or property damage. These symbols and their meanings are shown below. Please read and understand these symbols before proceeding to read this manual.

	WARNING	Instructions shown with this symbol represent what can cause death or serious injury if not observed.
	CAUTION	Instructions shown with this symbol represent what may cause injury or property damage if not observed.

Examples of the Symbols



The symbols shown in the Δ mark represent those that require attention (including potential dangers and warnings). A depiction of the type of caution is shown inside the symbol (the left symbol indicates a general caution).



The symbols shown in the \ominus mark represent actions which are prohibited. A depiction of the type of prohibited action is shown inside the symbol (the left symbol indicates that disassembly is prohibited).



The \bullet symbol indicates required actions. A depiction of the type of required action is shown inside the symbol (the left symbol indicates that the power plug must be disconnected from the outlet).

Precautions Upon the Operation



WARNING



Do not disassemble or modify the equipment. Doing so may result in fire, electric shock, or equipment failure.



Do not allow the display to become wet. Doing so may result in fire, electric shock, or equipment failure.



Operate the equipment only at the indicated voltage. Failure to do so may result in fire, electric shock, or equipment failure.



Do not perform internal inspections or modifications of the equipment. Inspection or modification by unauthorized personnel may result in fire, electric shock, or equipment failure. Please consult with JRC or an affiliate to perform internal inspections or repair.



When disposing of the used lithium battery, place insulating tape over the battery terminals, or otherwise insulate the battery. Failure to do so may result in heating, explosion, or fire due to a shorted battery.



Install this unit at least 1 m away from any magnetic compasses. Installation near a magnetic compass may result in interference with the magnetic compass, and may result in an accident.



Do not perform internal inspections or modifications of the equipment. Inspection or modification by unauthorized personnel may result in fire, electric shock, or equipment failure. Please consult with JRC or an affiliate to perform internal inspections or repair.

Precautions Upon the Operation



CAUTION



Do not use the equipment in the environment other than those provided in the specification. Doing so may result in equipment failure, malfunction, or injury.



Do not install the equipment in the place subject to vibration or shock. Doing so may result in the equipment falling or collapsing, resulting in equipment failure or injury.



Do not place any item on the top of the equipment. Doing so may result in equipment failure, malfunction, or injury.



Please consult with JRC or an affiliate to perform installation. Installation by unauthorized personnel may result in malfunction.



Do not install the display unit in the location where it may come in contact with water, oil, or chemicals. Doing so may result in equipment failure, malfunction, or injury.



This equipment is not designed to automatically make judgments on the position data. The navigation information including the position data needs to be judged by the user himself.



Do not use benzine, alcohol or thinner when caring this equipment. Doing so may result in removing the paint or changing of properties. Wipe off the grime lightly with a dry soft cloth.



Use the indicated screws when installing the display unit to a stable wooden surface. Failure to do so may result in the display unit falling over, causing injury or property damage.



Use only the specified fuse. Failure to do so may result in fire or equipment failure.



Use only the specified battery. Failure to do so may result in equipment failure or malfunction.

CAUTION



When connecting the cable attached to the equipment, do not bend it acutely, twist it, or impart excessive force. Doing so sometimes causes cracks or damage to the coating, resulting in fire or electrocution.



Do not install the sensor where there is excessive vibration. Vibration may cause sensor failure.



Do not paint the sensor. Doing so may result in reception problems.



Do not install the sensor where temperature exceeds 55 degrees Celsius and there is covered with exhaust gas from funnel . Doing so may result in equipment failure or malfunction.



Use the fit cable, when connecting to the junction box.
Junction box rubber gaskets (25 f Gland side) fit ϕ 10mm – 20mm cables.



Install the sensor where there are no obstacles, in order to ensure that GPS signals can be directly received from satellites without interference or reflection of signals from surrounding objects.
Whenever possible, select a place with the following characteristics.

1. **An open space, which allows uniform reception of satellite signals.**
2. **Far away from any high power transmission antennas.**
3. **Outside radar beams.**
4. **Away from the INMARSAT antenna by at least 5 meters and outside the INMARSAT beam.**
5. **Away from the antenna of a VHF transmitter and a direction finder by at least 3 meters.**
6. **Away from a Magnetic Compass by at least 1 meter.**
7. **3 meters or more away from amateur radio antennas.**

If it is difficult to find an ideal site, select a place temporarily and install the equipment. Conduct a test to make sure that the proper performance can be obtained and then fix the equipment in position. If it is installed at an improper place, reception accuracy may be impaired.

Appearance of the Equipment

●NWZ-4610 Display Unit



●JLR-4341 DGPS Sensor Unit



●JLR-4340 GPS Sensor Unit



Terminology

Term	Meaning (Descriptions)
2D (2 dimension)	Positioning with antenna elevation height in addition to satellite data.
3D (3 dimension)	The three dimensional position fix, 4 or more satellites required.
Active route	Route that is currently used by a ship
Anchor alert	This alert monitors that the own ship is the preset distance or more away from the waypoint.
Arrival alert	This alert informs that the own ship has traveled the preset distance, approaching the waypoint.
Beacon information	Beacon data which is broadcast by message type 16.
CCRP	Abbreviation of Consistent Common Reference Point. Reference position of the own ship.
CDI	Abbreviation of Course Deviation Indicator. This indicator shows information on the deviation from the scheduled route and on the direction into which the ship should be steered.
Checksum	An error detection method to check that the data has been correctly transmitted.
COG	Course Over Ground.
Course	Direction in which the ship is traveling, which is the bearing mainly displayed by the GPS.
DISP-DPU	The main circuitry of display unit.
DGPS	Abbreviation of Differential Global Positioning System. GPS satellite error data sent from a reference station whose position is accurately known is received via beacon from a beacon station, improving positioning accuracy.
FRAM	Nonvolatile memory using a ferroelectric substance.
Geodetic	Conditions for expressing position via latitude and longitude.
GPS Satellite (GPS)	Abbreviation of Global Positioning System. Refers to satellites launched for navigational support of military vessels managed by the United States Department of Defense.
HDOP	Abbreviation of Horizontal Dilution of Precision. Indicates accuracy of positioning. The smaller the number, the higher the accuracy. If GPS satellites are unevenly distributed, this number will grow. If GPS satellites are evenly distributed, this number will be smaller.
IEC	IEC is the abbreviation of International Electrotechnical Commission. It is an international standard governing electrical and electronic technologies.
IPXX	IPXX is Degrees of protection provided by enclosures (IP Code) 1st numeral: Against ingress of solid foreign objects (0 – 6) 2nd numeral: Against ingress of water with harmful effects (0 - 8). (IPX4: splash-proof, IPX6: waterproof)
LCD Unit (LCD)	Liquid Crystal Display Unit.
Log Pulse	Contact output signal, output pulse per nm. Expressed in units of "p/nm". mi/h Unit of ship speed.
display	Method for expressing the present position with loran system time

	difference. (The method is for operators who have a background in loran navigation.)
Master reset	This function changes the settings of the display unit and GPS sensor back to the factory settings. The function clears all the data.
Multipath Wave	Waves received from multiple directions due to reflection or refraction of an initial wave by obstacles.
NMEA0183 (NMEA)	Abbreviation of National Marine Electrical Association 0183. International standard for naval equipment transmission established by the National Marine Electrical Association.
Positioning	Use of GPS or DGPS receiving functions to determine the current position of a ship.
RAIM Accuracy Standard (RAIM)	Abbreviation of Receiver Autonomous Integrity Monitoring. This system automatically detects failed satellites and deselects their positioning data from calculations. Including data from failed satellites will result in a decrease in positioning accuracy; the RAIM accuracy standard indicates the accuracy degradation base for removal of failed satellites from positioning calculations.
Ranging	Positioning with the use of SBAS satellite in addition to GPS satellite.
Reception Level	GPS signal reception level.
Route plan	Plan registered with multiple waypoints in the navigation order
RS-422	Balanced serial transmission standard.
RS-485	Balanced serial transmission standard.
SBAS	Abbreviation of Satellite Based Augmentation System. It is a blanket term for wide scale GPS support systems using fixed position satellites which send GPS error correction data over a wide range.
SBAS Search	SBAS reception mode (manual / automatic).
Smoothing	Function for averaging over a specified number of seconds.
SOG	Speed Over Ground, This is the ship's relative speed to the ground.
SPEED	The speed mainly measured by the GPS.
STW	Speed Through Water.
Symbol information	Information of symbols displayed on the plotting screen. The information includes symbol positions, comments, etc.
TD	Abbreviation of Time Difference. Time difference from the master-station signal of the loran system to the slave-station signal.
Message Type 0	SBAS satellite test broadcasting.
UTC	Abbreviation of Coordinated Universal Time.
XTD alert	This alert informs that the own ship has got out of the scheduled route by the preset distance or more.

Contents

FOREWORD.....	I
BEFORE COMMENCING THE OPERATION	II
PRECAUTIONS UPON THE OPERATION	III
PRECAUTIONS UPON THE OPERATION	IV
APPEARANCE OF THE EQUIPMENT.....	VI
TERMINOLOGY	VII
SECTION 1 EQUIPMENT OVERVIEW.....	1-1
1.1 FUNCTIONS	1-1
1.2 FEATURES	1-1
1.3 CONFIGURATION	1-2
1.3.1 Standard configuration	1-2
1.3.2 Option.....	1-3
1.4 CONSTRUCTION	1-4
1.5 SYSTEM DIAGRAM.....	1-19
SECTION 2 NAMES AND FUNCTIONS OF THE COMPONENTS	2-1
2.1 NWZ-4610 DISPLAY UNIT	2-1
2.2 JLR-4341 DGPS SENSOR	2-3
2.3 JLR-4340 GPS SENSOR.....	2-3
SECTION 3 DISPLAY SCREEN	3-1
3.1 DISPLAY SCREEN	3-1
SECTION 4 OPERATION	4-1
4.1 MENU LIST	4-1
4.2 BASIC OPERATION	4-7
4.2.1 Turning the Unit On.....	4-7
4.2.2 Turning off the power	4-10
4.2.3 Adjusting the Backlight by using the kry	4-10
4.2.4 Adjusting contrast	4-10
4.2.5 Turning off the buzzer	4-11
4.2.6 Switching display	4-11
4.2.7 Alert display.....	4-11
4.2.8 Selecting items from the menus.....	4-12
4.2.9 Entering a numeric value	4-13
4.3 PLOT SCREEN OPERATION.....	4-14
4.3.1 Cursor Operation	4-14
4.3.2 Zooming the Screen In and Out.....	4-14
4.3.3 Centering the Own Ship on the Screen	4-15
4.3.4 Registering the corsor position	4-15
4.3.5 Registering the Own ship's position.....	4-15
4.3.6 Track Display	4-15
4.3.7 Waypoint Symbol and Route Display.....	4-16
4.3.8 Changing Route into Track	4-18
4.4 REGISTERING WAYPOINTS	4-19
4.4.1 Displaying the Waypoint List.....	4-19
4.4.2 Registering Waypoints	4-19
4.4.3 Editing Waypoint Information	4-22
4.4.4 Copying Waypoint Information.....	4-23
4.4.5 Deleting Waypoints	4-23
4.5 ROUTE PLANNING	4-24
4.5.1 Displaying the Route List	4-24
4.5.2 Creating Routes	4-25
4.5.3 Editing Routes.....	4-27
4.5.4 Copying Routes	4-30
4.5.5 Deleting Routes	4-31
4.6 PERFORMING NAVIGATION	4-32
4.6.1 Selecting a Route from the Route List.....	4-32
4.6.2 Selecting a Waypoint/Route with the GOTO Key	4-33

4.6.3	Stopping Navigation	4-36
4.7	ENTERING COMMENTS.....	4-37
4.7.1	Text Entry	4-37
4.7.2	Deleting Text	4-38
4.7.3	Adding Text	4-39
4.7.4	Canceling Comment Entry	4-39
4.8	MOB	4-40
4.9	SETTING DISPLAY	4-41
4.9.1	Adjusting contrast	4-41
4.9.2	Adjusting back light	4-41
4.9.3	Setting a click sound	4-42
4.9.4	Setting a display screen.....	4-42
4.9.5	Selecting a back light color	4-46
4.10	SYSTEM SETTINGS	4-47
4.10.1	Setting Speed and Antenna height Unit	4-47
4.10.2	Setting the Time Difference.....	4-47
4.10.3	Setting the Date Display	4-48
4.10.4	Setting Magnetic Correction.....	4-48
4.10.5	Displaying as Loran C time difference	4-49
4.10.6	Setting the Geodetic System	4-49
4.11	LANGUAGE SETTINGS	4-50
4.12	ALERT SETTINGS.....	4-51
4.12.1	Setting a system alert	4-51
4.12.2	Setting a vessel speed alert.....	4-52
4.12.3	Setting a TRIP alert.....	4-52
4.12.4	Setting ARRIVAL/ANCHOR Alert	4-52
4.12.5	Setting XTD Alert	4-53
4.12.6	Setting DGPS Alert	4-53
4.12.7	Setting HDOP Alert	4-54
4.12.8	Setting a buzzer sound and screen back light	4-54
4.13	GPS/BEACON/SBAS SETTINGS.....	4-55
4.13.1	Setting GPS Mode	4-55
4.13.2	Setting FIX Mode	4-56
4.13.3	Setting Elevation Mask	4-56
4.13.4	Setting HDOP.....	4-56
4.13.5	Setting Position, Speed, and Course Smoothing.....	4-57
4.13.6	Setting RAIM.....	4-57
4.13.7	Initializing the GPS.....	4-58
4.13.8	Setting Beacon.....	4-59
4.13.9	Setting SBAS	4-60
4.14	BEACON INFORMATION.....	4-61
4.15	EQUIPMENT CONFIGURATION.....	4-62
4.15.1	Changing to a maintenance mode	4-62
4.15.2	Setting a model	4-63
4.15.3	Selecting a dimmer unit	4-63
4.15.4	Dimmer linked control and data sharing with RS-485.....	4-64
4.15.5	Setting a serial port	4-67
4.15.6	Setting Contact Input	4-69
4.15.7	Setting Contact Output.....	4-70
4.15.8	Outputting Alert history.....	4-70
4.15.9	Checking installation	4-70
4.15.10	Performing a Master Reset (Reset)	4-73
4.15.11	Performing a Demo	4-74
4.15.12	Setting the Sub Display.....	4-74
4.15.13	Setting the GPS Sensor Number	4-75
4.15.14	Outputting setting value	4-75
4.15.15	Setting Sensor Position / CCRP	4-76
4.15.16	Calculating Trip Distance	4-76
4.15.17	Inputting/Outputting Waypoint, Route and Track.....	4-77
SECTION 5 MAINTENANCE AND INSPECTION.....		5-1
5.1	GENERAL MAINTENANCE AND INSPECTION	5-1
5.2	ALERTS	5-2
5.3	TROUBLESHOOTING.....	5-3

5.3.1	Troubleshooting	5-3
5.3.2	Repair Unit	5-4
5.3.3	Regular Replacement Parts	5-4
SECTION 6 INSTALLATION		6-1
6.1	GPS SENSOR INSTALLATION	6-2
6.1.1	Selecting the Position for Installation	6-2
6.1.2	Sensor Installation Procedure	6-3
6.1.3	Installation of the Sensor on the Mast	6-4
6.1.4	Installation of the Sensor to Pass a Cable through a Pole	6-5
6.2	AFFIXING DISPLAY UNIT NAMEPLATE LABELS	6-7
6.2.1	Affixing Product Nameplate	6-7
6.2.2	Affixing Model Identification Plate	6-7
6.3	DISPLAY UNIT INSTALLATION	6-8
6.3.1	Selecting the Position for Installation	6-8
6.3.2	Mounting the display unit using a rack	6-9
6.3.3	Mounting using a flash mount	6-11
6.3.4	Removing the display unit by flash mounting	6-13
6.4	CABLE CONNECTION	6-14
6.4.1	DC12/24V DATA Connector	6-15
6.4.2	DATA1 Connector	6-18
6.4.3	SENSOR/DATA2 Connector	6-22
6.5	OPTIONAL PERIPHERAL CONNECTION	6-24
6.5.1	Sub-Display Connection	6-24
6.5.2	Printer Connection	6-24
6.5.3	Dimmer Unit Connection	6-25
6.5.4	Junction Box Connection	6-26
6.5.5	Coaxial Cable Kit Connection	6-28
6.5.6	Output buffer (NQA-4351)	6-29
6.5.7	GPS Select Switch (Manual) (NCZ-1663)	6-29
6.5.8	GPS Select Switch (Automatic) (NCZ-1537B)	6-29
SECTION 7 AFTER-SALES SERVICE		7-1
7.1	WARRANTY	7-1
7.2	REPAIR PARTS STOCKING PERIOD	7-1
7.3	WHEN REQUESTING SERVICE	7-1
7.4	RECOMMENDED CHECKS AND INSPECTION	7-1
SECTION 8 DISPOSAL		8-1
8.1	DISPOSAL OF THE EQUIPMENT	8-1
8.2	DISPOSAL OF USED BATTERIES	8-1
SECTION 9 SPECIFICATION		9-1
9.1	NWZ-4610 DISPLAY UNIT	9-1
9.1.1	Basic Specification	9-1
9.1.2	Environment	9-1
9.1.3	External Interface	9-2
9.2	JLR-4341 DGPS SENSOR	9-3
9.2.1	Basic Specification	9-3
9.2.2	Environment	9-3
9.3	JLR-4340 GPS SENSOR	9-4
9.3.1	Basic Specification	9-4
9.3.2	Environment	9-4
APPENDIX		
APPENDIX1	LIST OF GEODETIC SYSTEM	1
APPENDIX2	LIST OF STANDARD TERMS, UNITS AND ABBREVIATIONS	2
APPENDIX3	DEFAULT VALUE	7
APPENDIX4	SETTING VALUE MEMO	10
APPENDIX5	LIST OF SYMBOLS	14
APPENDIX6	COMPASS SAFE DISTANCE	15

Section 1 Equipment Overview

1.1 Functions

This equipment (JLR-7900/JLR-7600) is a GPS navigator with a JLR-4341 DGPS or JLR4340 GPS sensor being connected to the NWZ-4610 display unit.

The GPS navigator operates around-the-clock to measure the position with high accuracy anywhere in the world and in all weather conditions by using the GPS satellites. In addition, the GPS navigator can increase the accuracy of position fixing by receiving correction data from the DGPS beacon station and SBAS satellites.

1.2 Features

- Availability of three output ports
- High visibility by using 4.5-inch liquid crystal display
- Improvement of operability by using various menus
- Built-in SBAS function
- Built-in RAIM function

1.3 Configuration

1.3.1 Standard configuration

JLR-7900

No.	Name	Model	Code	Q'ty	Note
1.1	Display Unit	NWZ-4610	NWZ-4610	1	Main body
1.2	Data Power Cable	CFQ-5766A	CFQ5766A	1	14 cores/2 m/with Fuse holder data/contact/power
1.3	Fuse	MF60NR 250V 1	5ZFGD00205	2	Display unit 1A fuse
1.4	FRONT PANEL	MTV305018A	MTV305018A	1	
1.5	BASE KITS	MPBX47065	MPBX47065	1	Base Knob Bolt Gear Washer Knob Washer
1.6	Model Identification Plate	MPNN47524A	MPNN47524A	1	For Rear
1.7	Product Name Plate	MPNN47529A	MPNN47529A	1	For Front
1.8	Flush Mounting Drawing	-	-	1	For Flush Mount
1.9	Instruction Manual	7ZPNA4352	7ZPNA4352	1	English/Japanese
2.1	DGPS Sensor	JLR-4341	JLR-4341	1	
2.2	Instruction Manual	7ZPNA4162	7ZPNA4162	1	English
2.3	Cable Guard Rubber	MPPK31468	MPPK31468	1	
3	Screw Adapter	MTV302007A	MTV302007A	1	
4	Mounting Band	MPBP02520	MPBP02520	1	Include 2 bands

JLR-7600

No.	Name	Model	Code	Q'ty	Note
1.1	Display Unit	NWZ-4610	NWZ-4610	1	
1.2	Data Power Cable	CFQ-5766A	CFQ5766A	1	14 cores/2 m/with Fuse holder data/contact/power
1.3	Fuse	MF60NR 250V 1	5ZFGD00205	2	1A fuse
1.4	FRONT PANEL	MTV305018A	MTV305018A	1	
1.5	BASE KITS	MPBX47065	MPBX47065	1	Base Knob Bolt Gear Washer Knob Washer
1.6	Model Identification Plate	MPNN47524A	MPNN47524A	1	Rear
1.7	Product Name Plate	MPNN47529A	MPNN47529A	1	Front
1.8	Flush Mounting Drawing	-	-	1	For Flush Mount
1.9	Instruction Manual	7ZPNA4352	7ZPNA4352	1	English/Japanese
2.1	GPS Sensor	JLR-4340	JLR-4340	1	
2.2	Instruction Manual	7ZPNA4008	7ZPNA4008	1	English
3	Screw Adapter	MTV302007A	MTV302007A	1	
4	Mounting Band	MPBP02520	MPBP02520	1	Include 2 bands

1.3.2 Option

No.	Name	Model	Code	Q'ty	Note
1	AC Power Rectifier	NBG-320	NBG-320	1	AC100/220V input 12V output
2	AC Power Rectifier	NBD-577C	NBD-577C	1	AC100/220V input 24V output
3	Data Power Cable	CFQ-5766D	CFQ5766D	1	14 cores/10 m/ With Fuse holder data/contact/power
		CFQ-5766F	CFQ5766F	1	14 cores/20 m/ With Fuse holder data/contact/power
4	Data Cable	CFQ-5769	CFQ5769	1	4 cores/3 m/RS-485
5	T-shaped Connector	AA-040404-MMM-TL	5JCDX00071	1	For RS-485
6	Junction Box	CQD-10	CQD-10C	1	16 terminals
7	Dimmer Unit	NCM-227	NCM-227-7 NCM-227-2	1	External dimmer unit 7.5BG7/2 2.5G7/2
8	L-TYPE ADAPTER	CFQ-9184	CFQ9184	1	
9	Printer	NKG-94	NKG-94	1	
10	Printer Paper	H-7ZPJD0384	7ZPJD0384	1	
11	Extension Cable	CFQ-9000	CFQ-9000	1	15 m/6 cores/ For Sensor
12	Junction Box	NQE-7700A	NQE-7700AA	1	
13	Pole Mounting Kit	MPBP30608	MPBP30608		For NQE-7700A
14	Coaxial Cable Kit	NQD-4414	NQD-4414A	1	
15	Output Buffer	NQA-4251A/4351	NQA-4251A/4351	1	
16	GPS Select Switch	NCZ-777/1663	NCZ-777AN4 NCZ-777A2/1663-2 NCZ-777A7/1663-7 NCZ-1663N2	1	Manual switch N4 2.5G7/2 7.5BG7/2 N2.5
17	GPS Select Switch	NCZ-1537B	NCZ-1537B	1	Automatic switch
18	Instruction Manual	7ZPNA4288	7ZPNA4288	1	English
19	Printer	NKG-104	NKG104	1	

1.4 Construction

- **NWZ-4610 Display Unit**

NWZ-4610 Desktop type

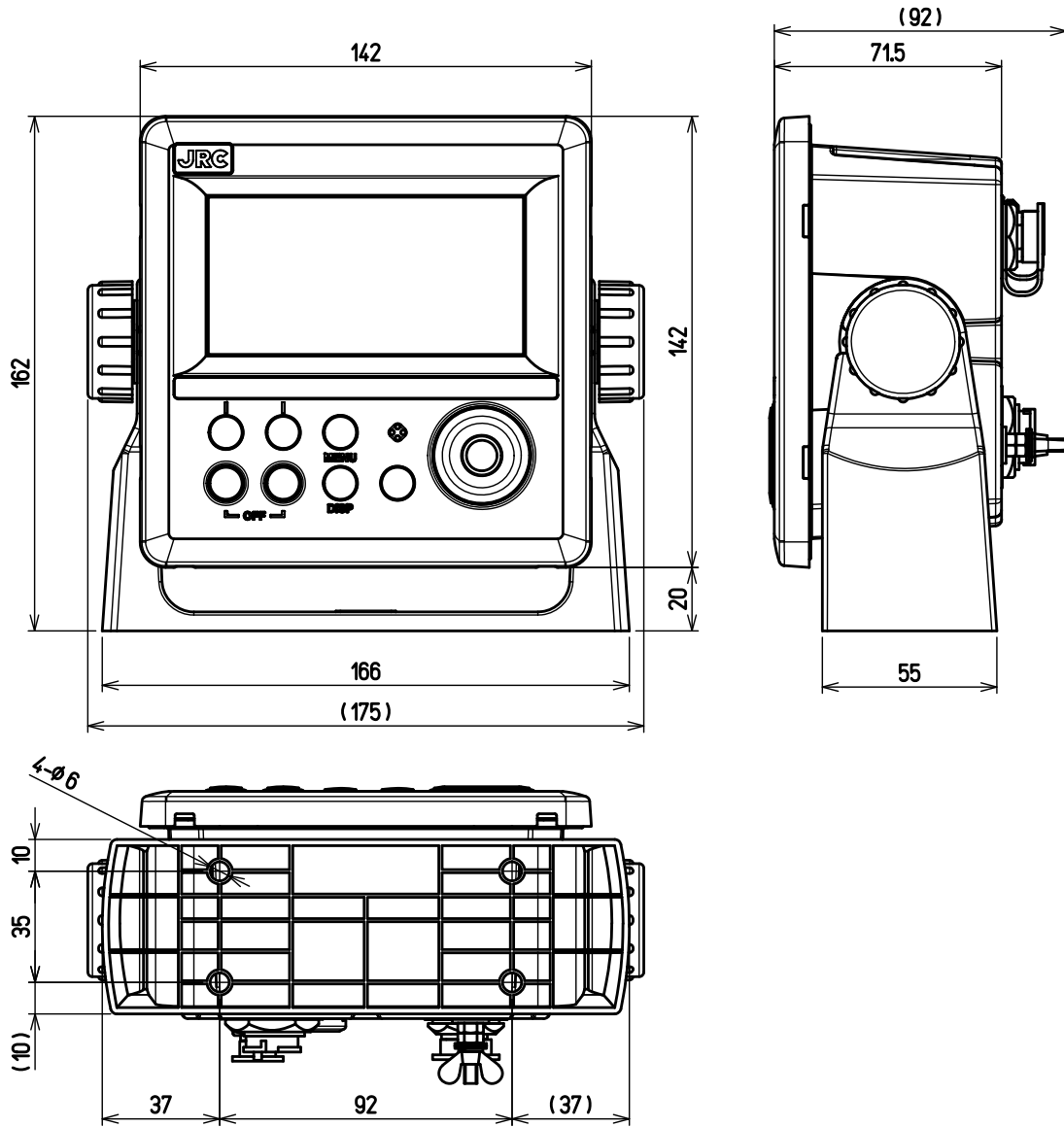

Unit: mm
Mass: Approximately 0.8 kg

- **JLR-4341 DGPS Sensor Unit**

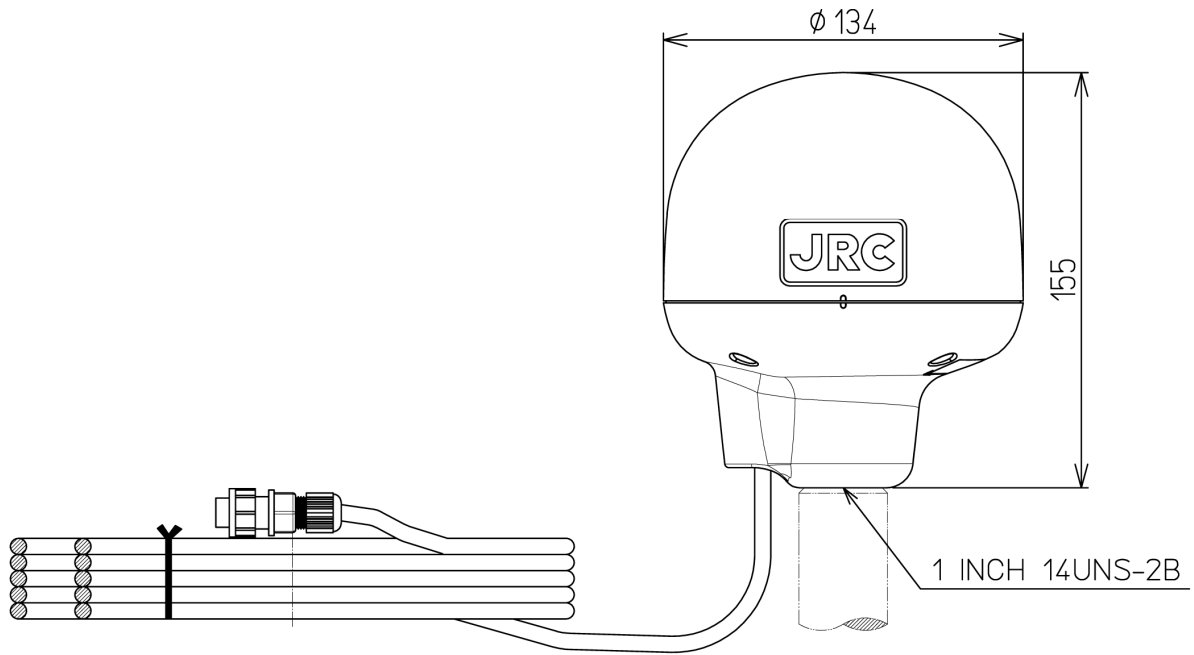

Unit: mm
Mass: Approximately 1.7 kg
(including 15m cable)

- **JLR-4340 GPS Sensor Unit**

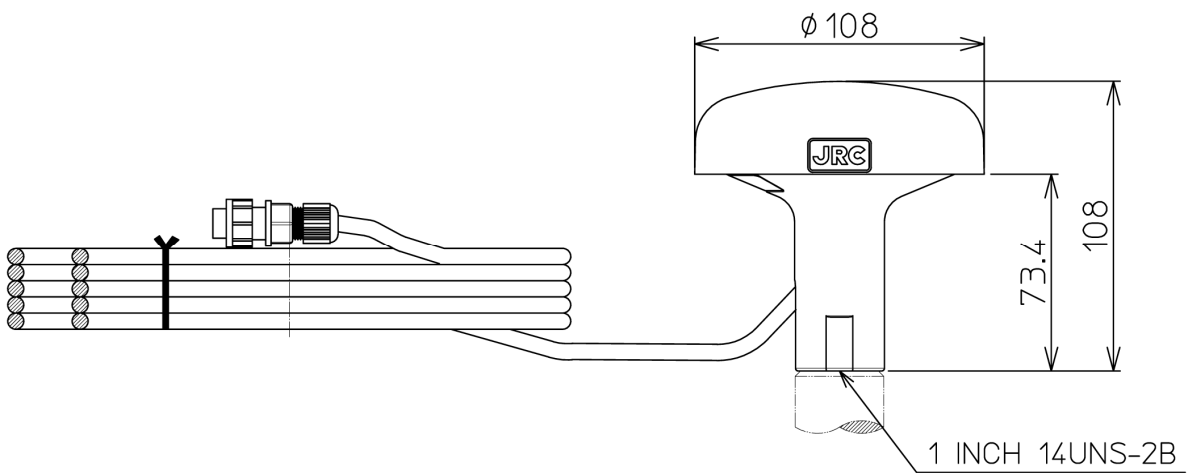

Unit: mm
Mass: Approximately 0.7 kg
(including 10m cable)

• **NBG-320 Power Supply Outline Drawing**

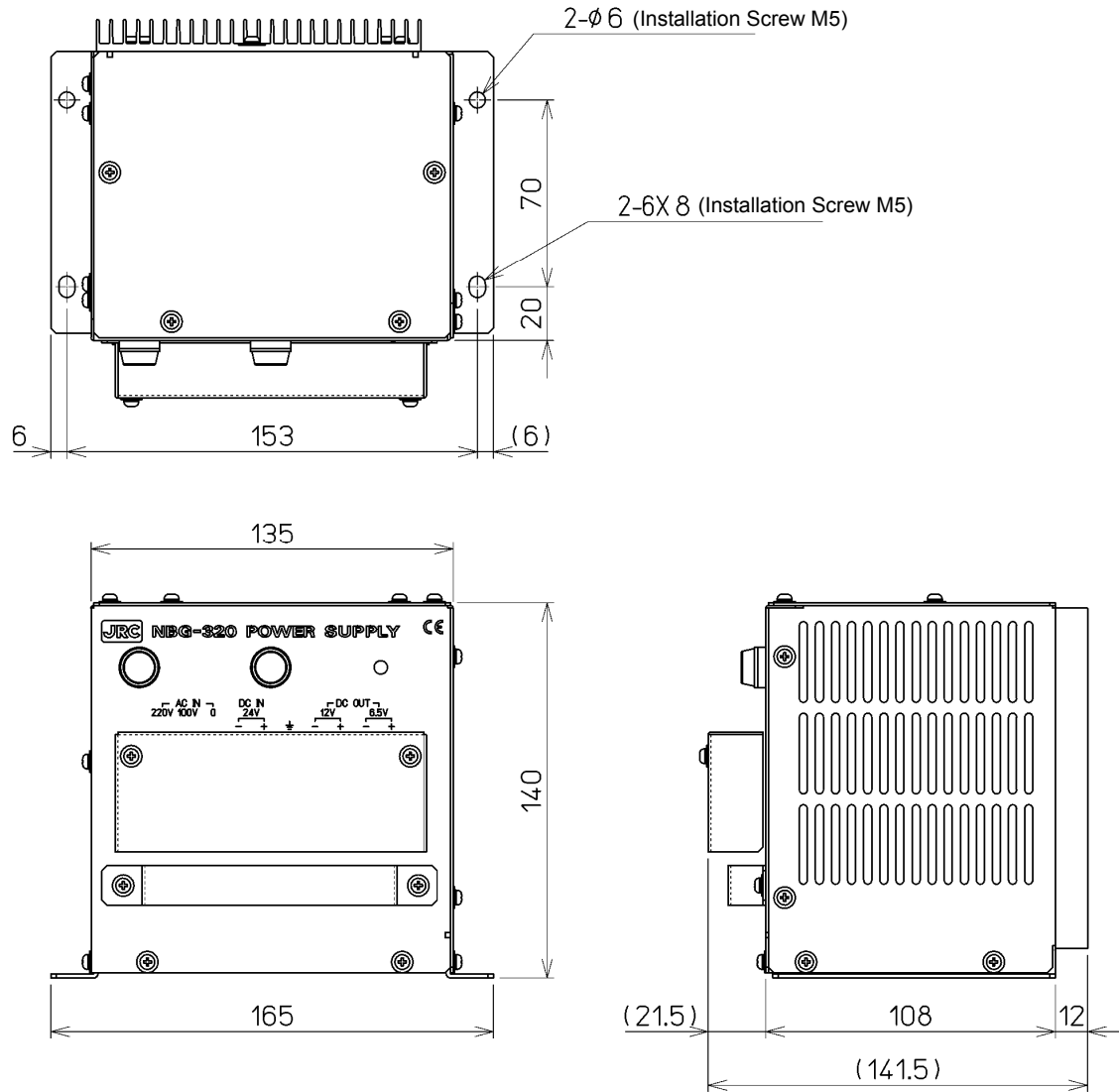

Unit: mm
 Mass: Approximately 3.5 kg

- **NBD-577C Power Supply Outline Drawing**

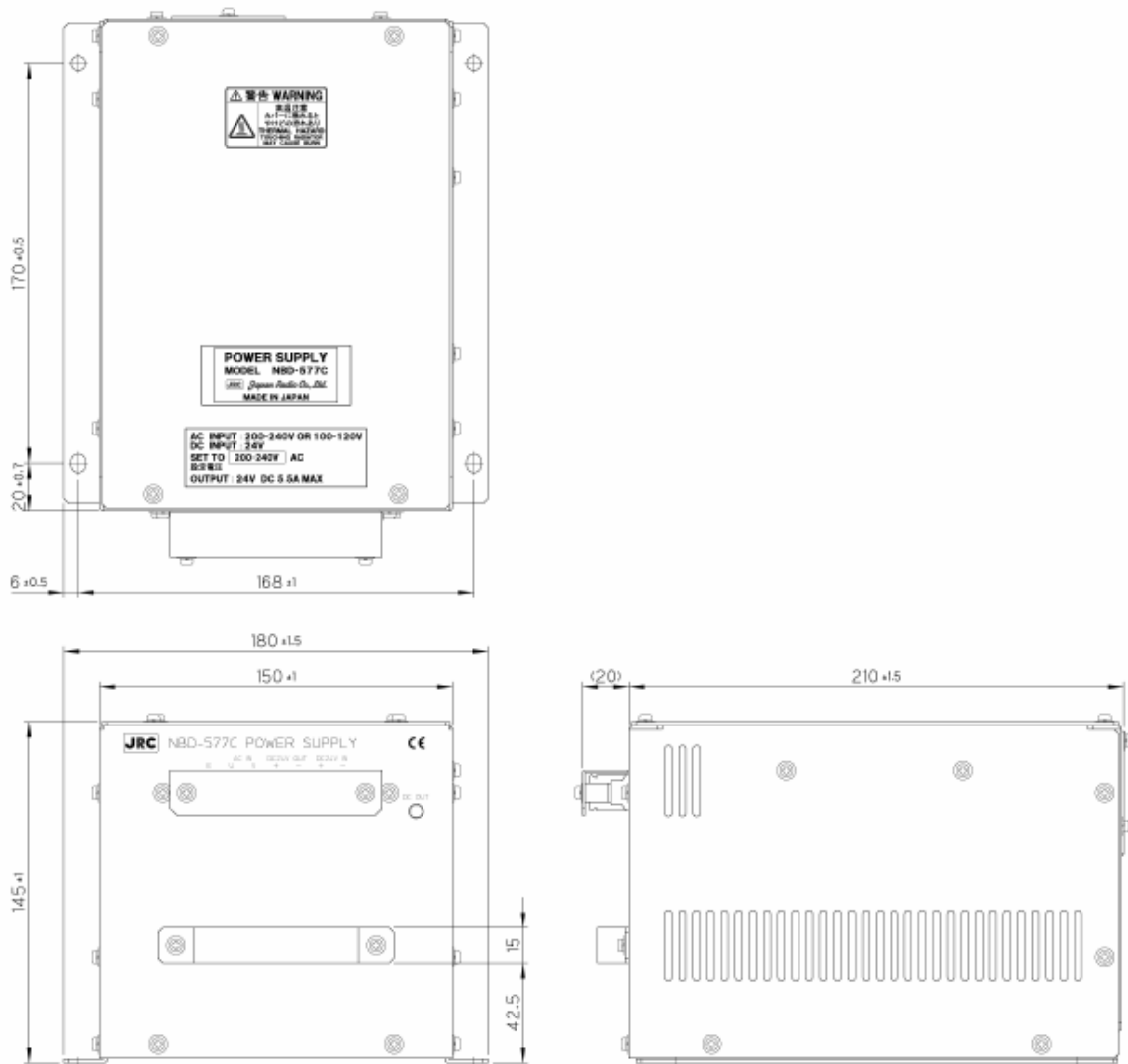

Unit: mm
 Mass: Approximately 5.4 kg

• **NQE-7700A Junction Box Outline Drawing**

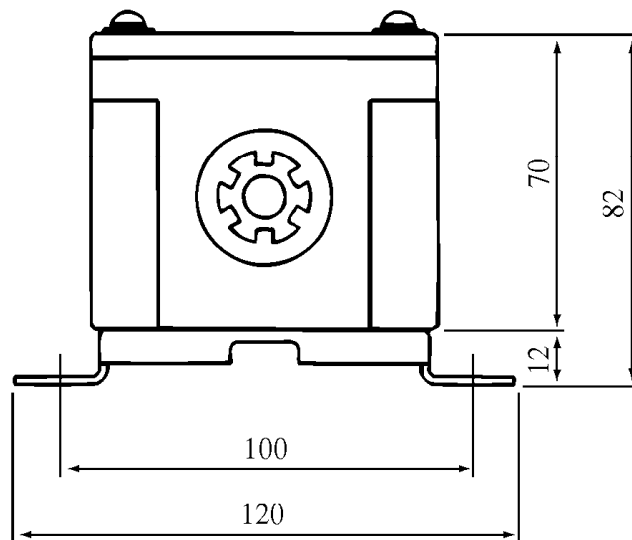
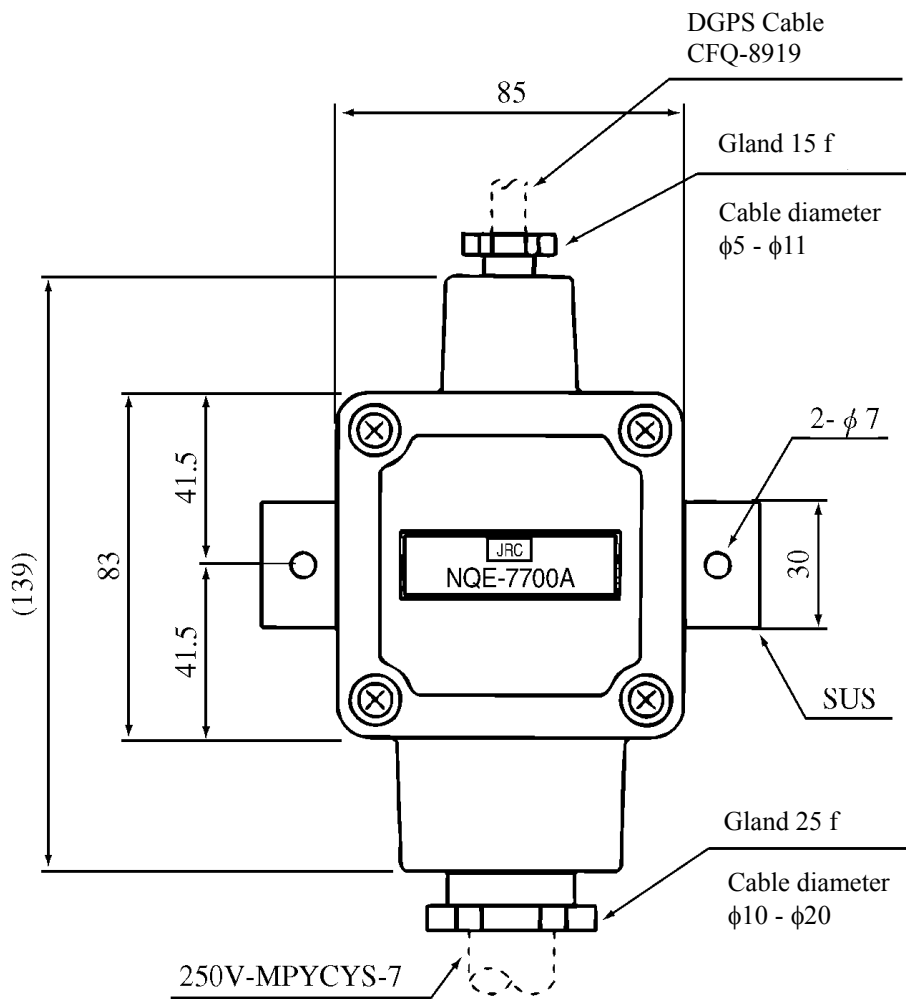

Unit: mm
Mass: Approximately 0.6 kg

• **NQD-4414 Coaxial Cable Kit (outdoor use: NQD-4410) Outline Drawing**

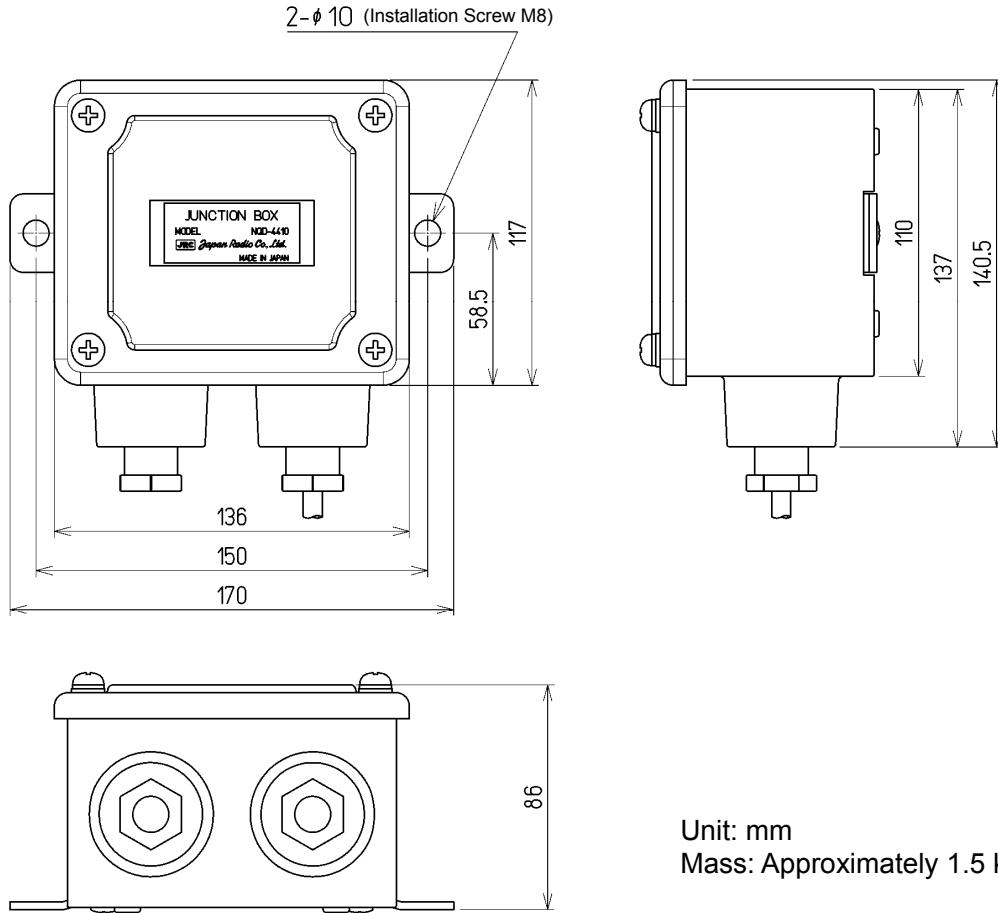

• **NQD-4414 Coaxial Cable Kit (indoor use: NQD-4411) Outline Drawing**

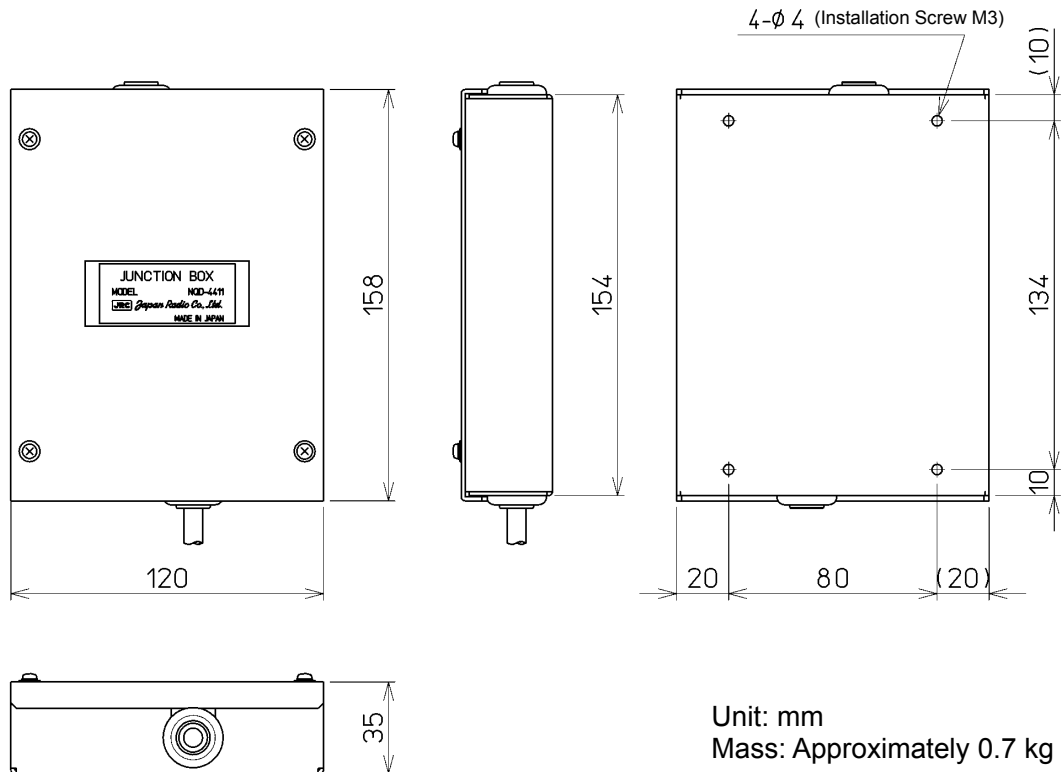

• **NQA-4251A Output Buffer Outline Drawing**

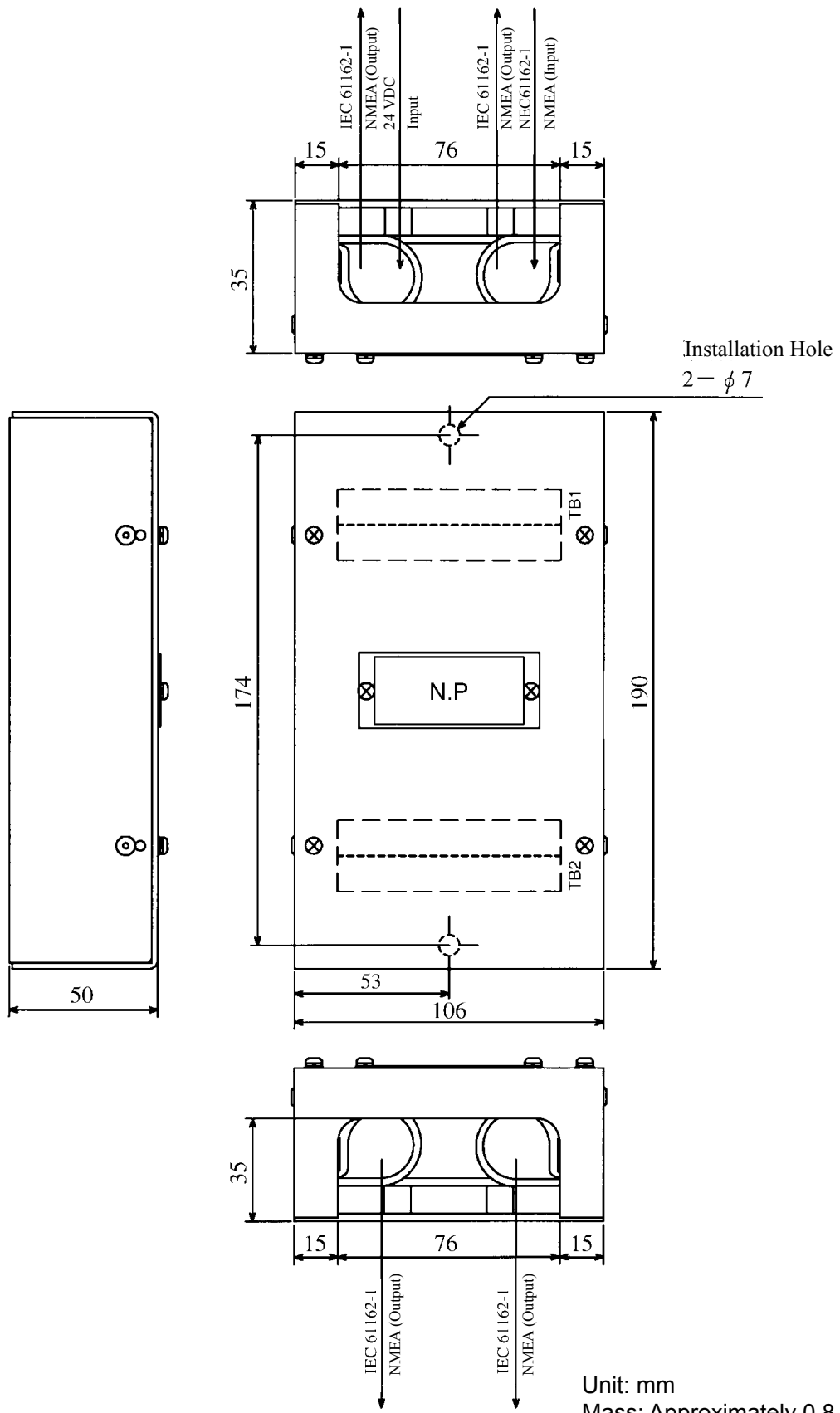

Unit: mm
Mass: Approximately 0.8 kg

• **NQA-4351 Output Buffer Outline Drawing**

DC INPUT (IEC 61162-1 OR NMEA) DATA INPUT (IEC 61162-1 OR NMEA)
SELECT SIGNAL

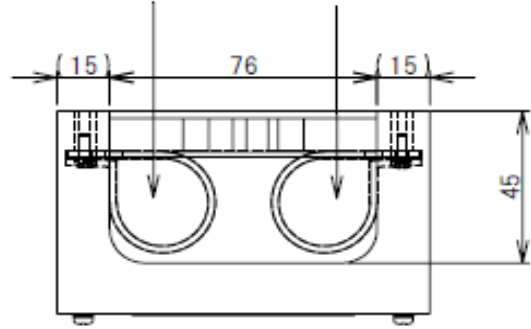

MOUNTING HOLES (2-dia 7)
(INSTALLATION SCREW M6)

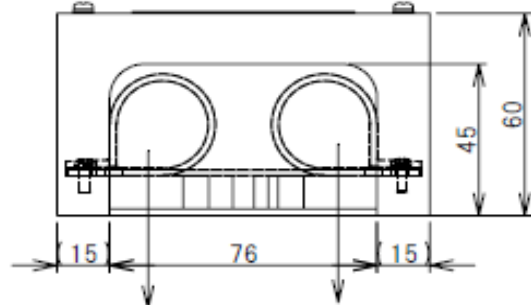
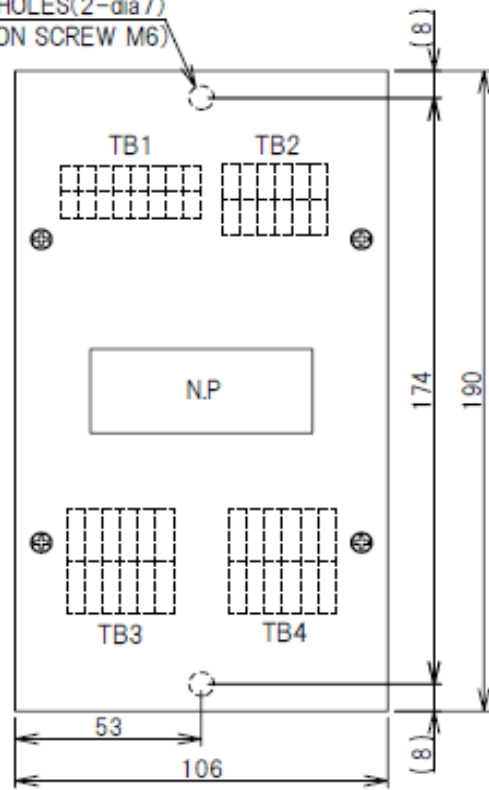

DATA OUT (IEC 61162-1 OR NMEA) DATA OUT (IEC 61162-1 OR NMEA)

Note:

JUMPER OF DC INPUT VOLTAGE	
DC input voltage	Jumper of Terminal
DC 12V input	<p>TB1-IN</p> <p>JUMPER ON 9-16V</p> <p>Jumper cable (Cable of 0.25 - 2.5 sq)</p>
DC 24V input	<p>TB1-IN</p> <p>Not connect</p> <p>JUMPER ON 9-16V</p>

Unit: mm

Mass: Approximately 0.8 kg

• **NCZ-777 Select Switch (Stationary) Outline Drawing**

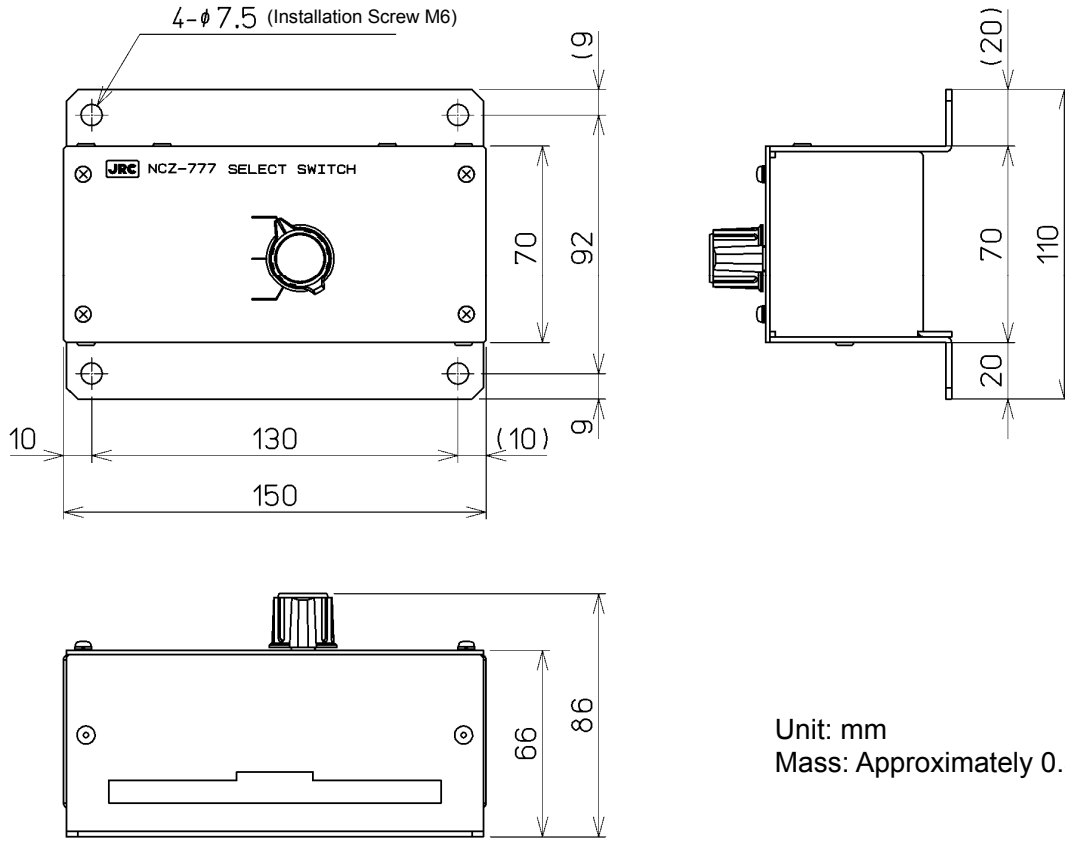

• **NCZ-777 Select Switch (Flush Mounting) Outline Drawing**

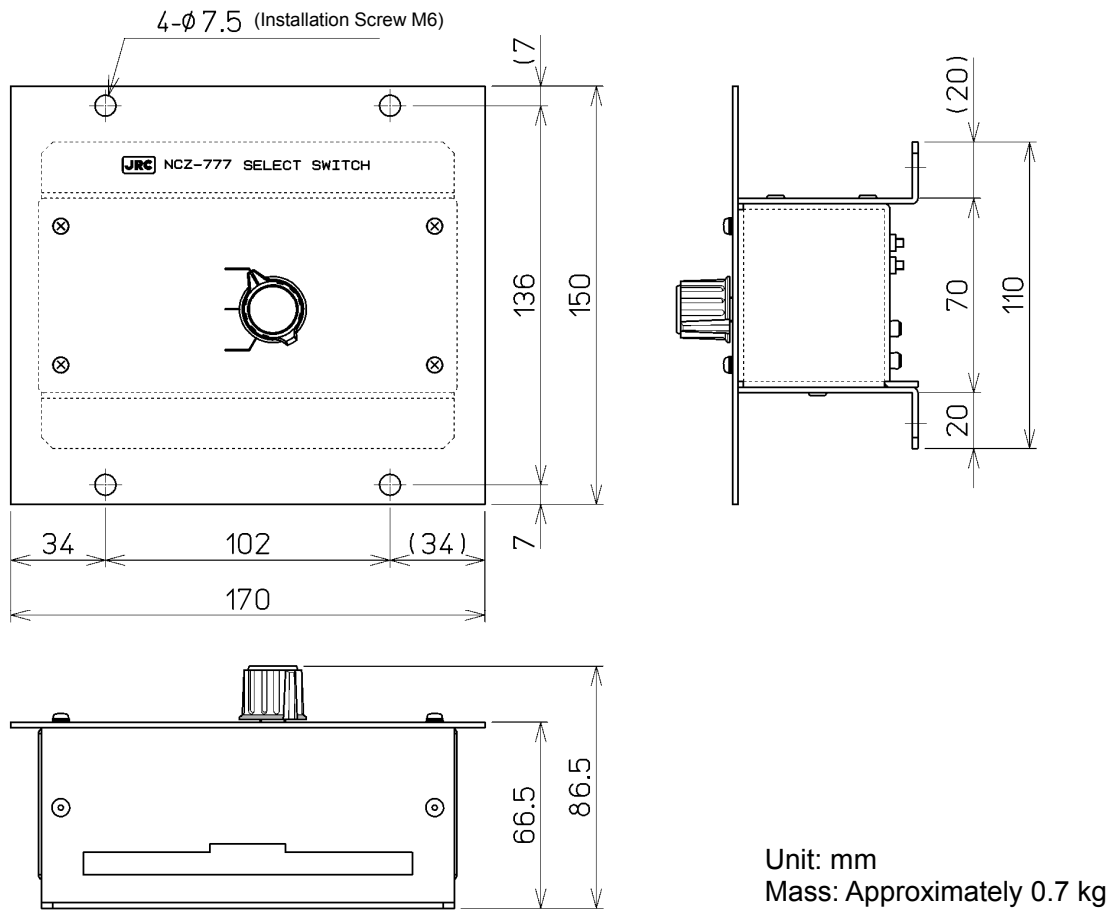

- **NCZ-1663 Select Switch**

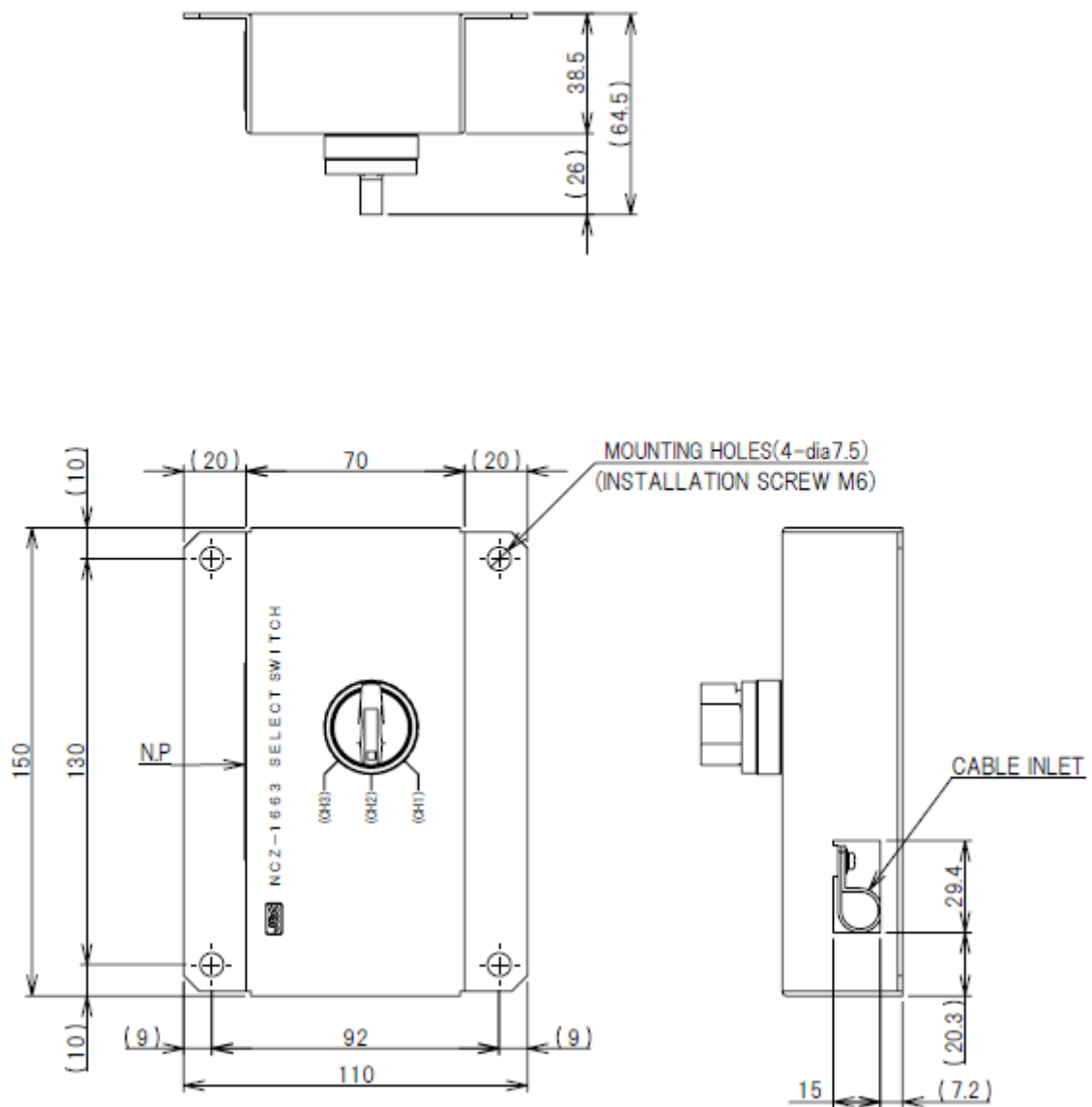

Unit: mm
Mass: Approximately 0.2 kg

- **NCZ-1663 Select Switch (Flush Mounting)**

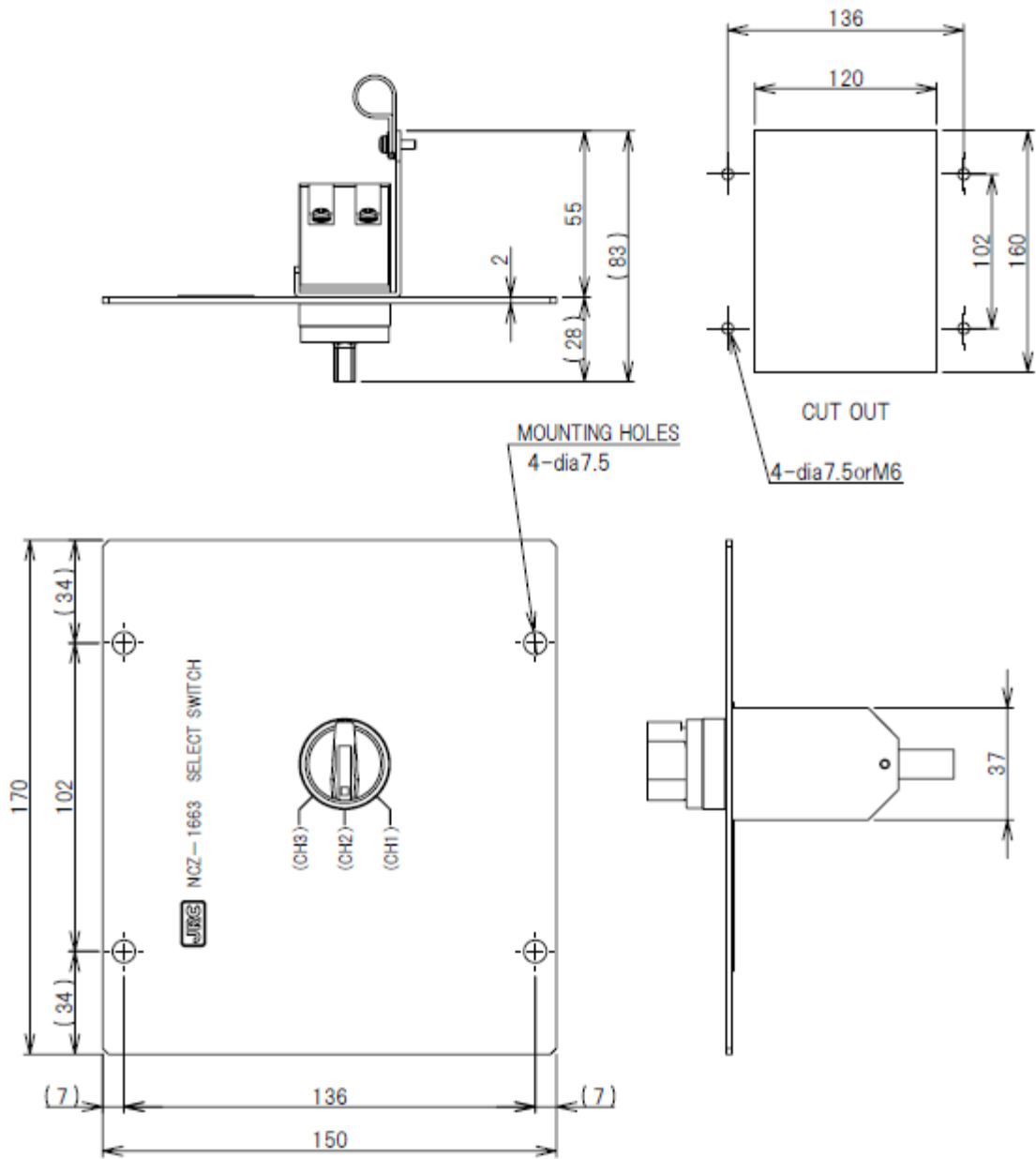

Unit: mm
 Mass: Approximately 0.2 kg

- **NCZ-1537B Select Switch (Flush Mounting)**

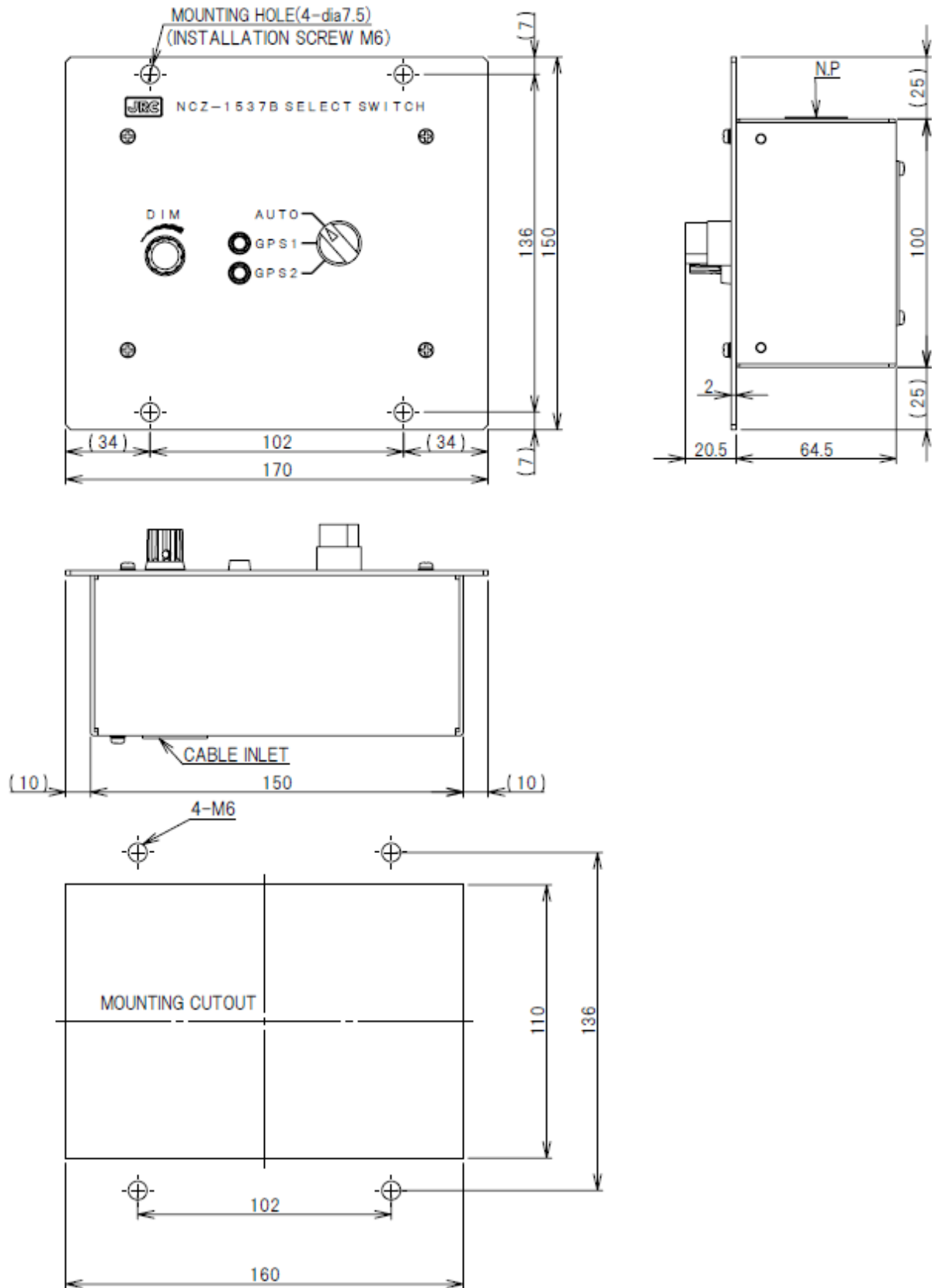

Unit: mm
 Mass: Approximately 0.55 kg

• **CQD-10 Junction Box Outline Drawing**

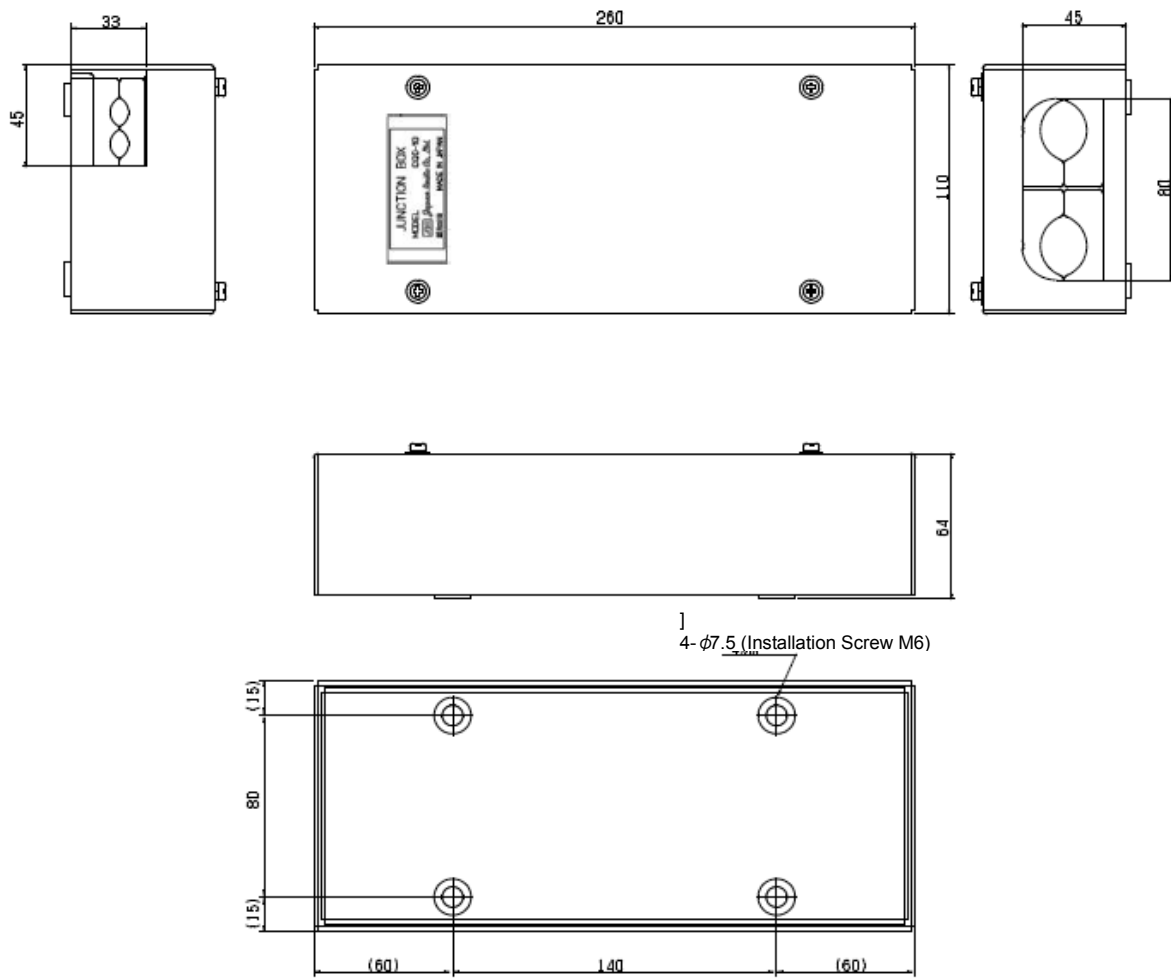

Unit: mm
Mass: Approximately 1.1 kg

• **NKG-94 Printer Outline Drawing**

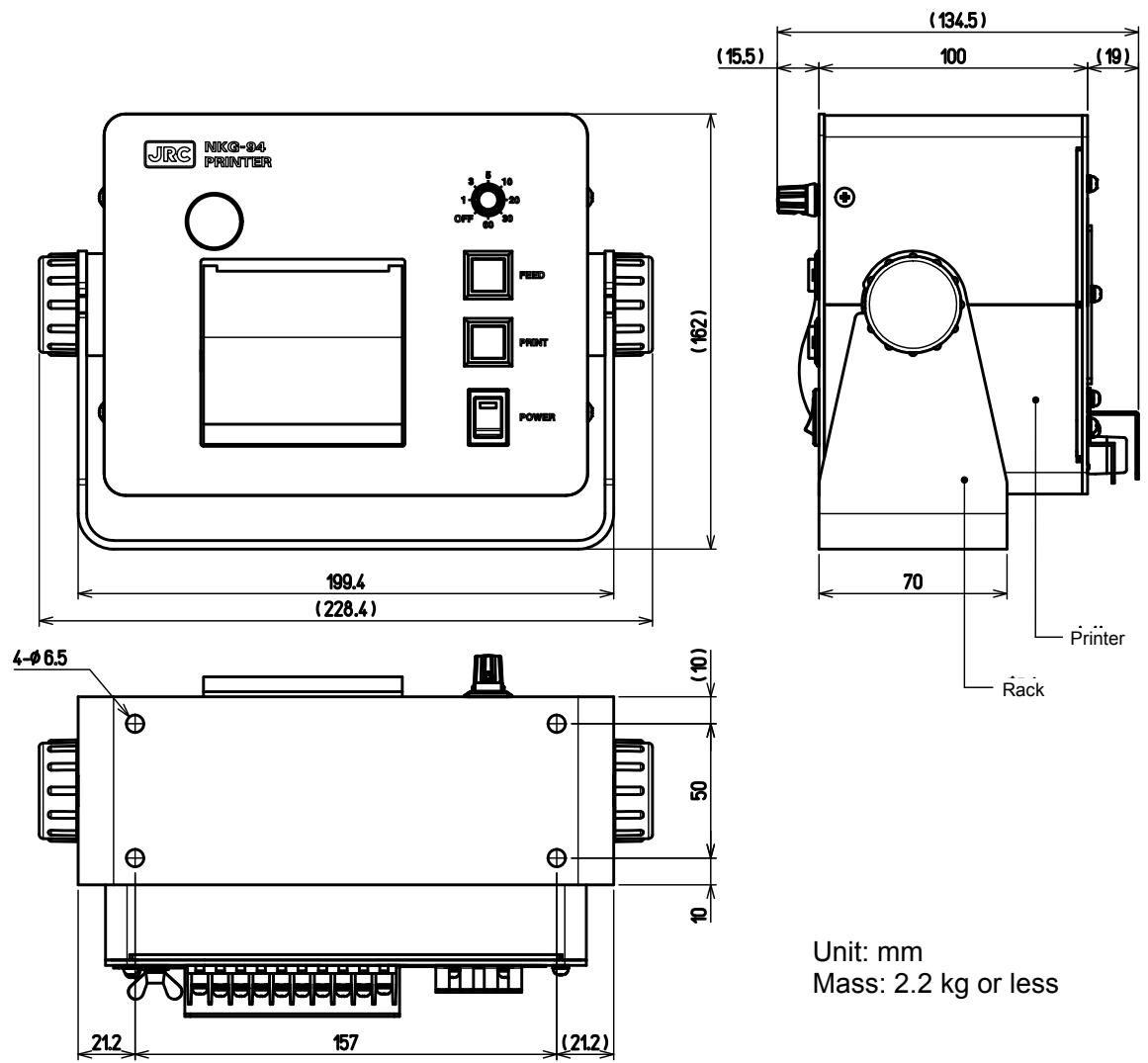

Unit: mm
 Mass: 2.2 kg or less

NKG-104 Printer Outline Drawing

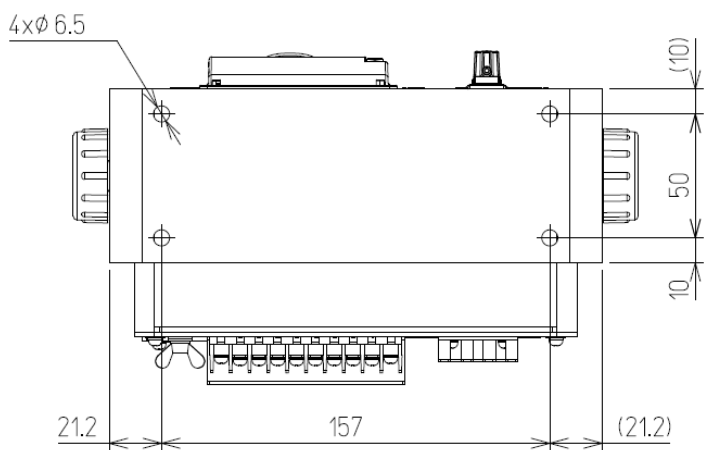
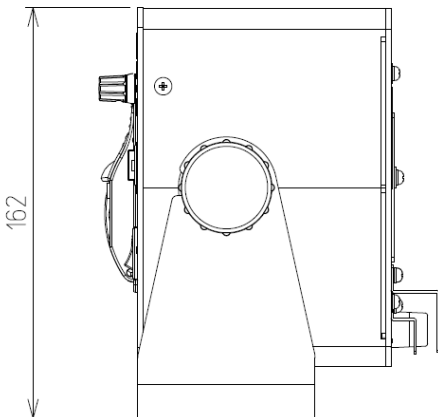
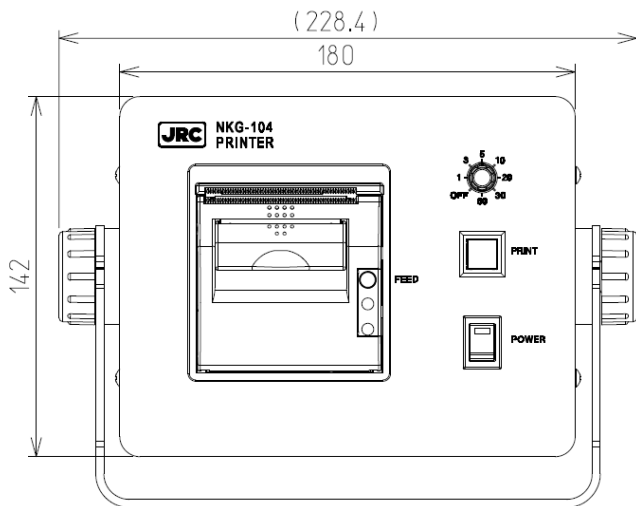

Unit: mm
 Mass: 2.1kg or less

1.5 System Diagram

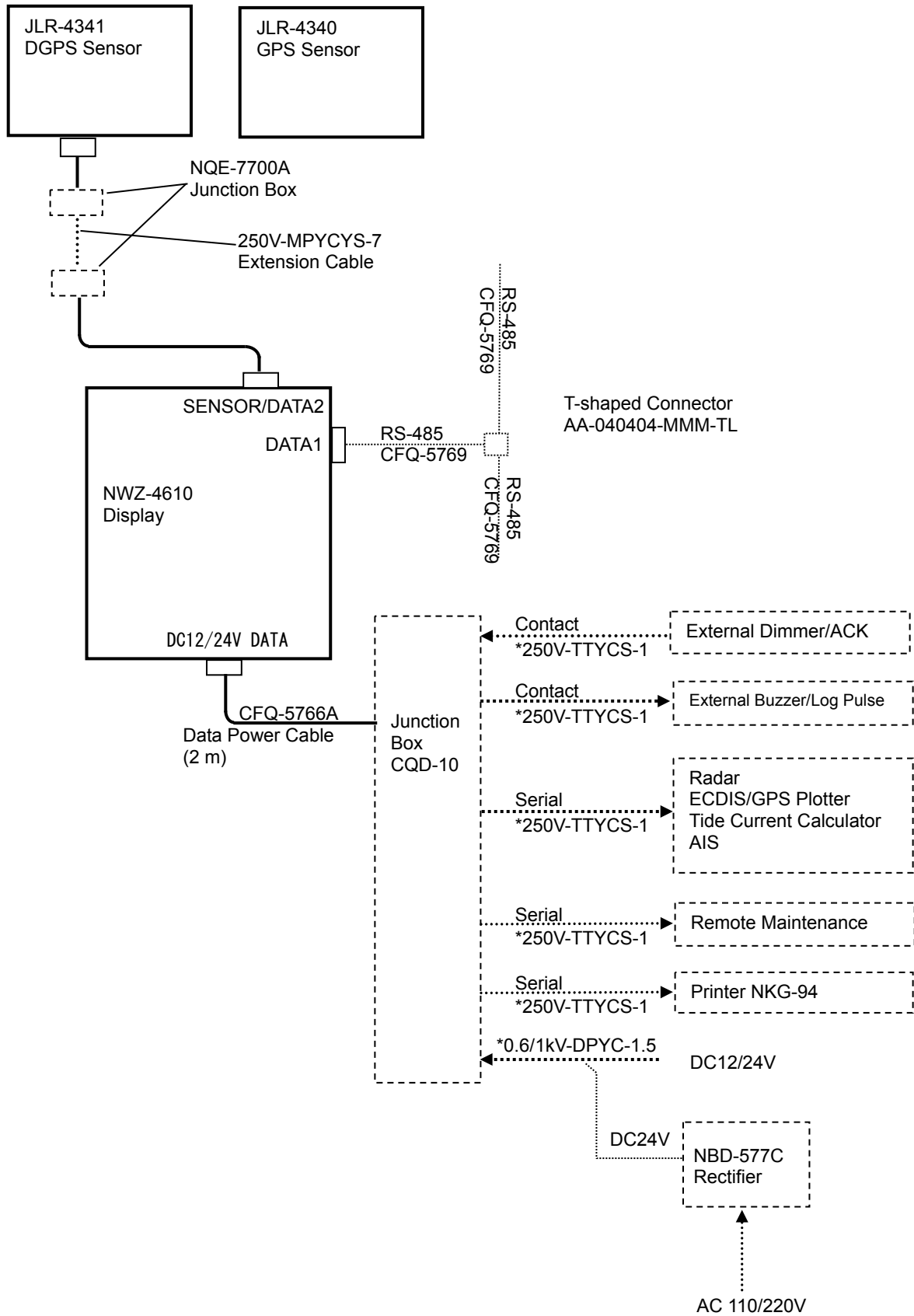

*Arranged by dockyard.

Section 2 Names and Functions of the Components

2.1 NWZ-4610 DISPLAY UNIT

- Unit (Front)

Display

Information received from the GPS sensor, the equipment setting screen, etc. are displayed.



Operation panel

No.	Operation panel	Name	Functions
1		Power/ Contrast key	Use this key to turn on the power. Adjust the contrast. To turn off the power, press this key together with the key.
2		Dimmer key	Use this key to adjust the brightness.
3		Menu key	Use this key to display the main menu.
4		Display key	Use this key to switch the display screen.
5		Clear key	Use this key to cancel the operation. Use this key also to stop the alert.
6		Cursor key	Use this key to move the cursor.
7		Enter key	Uses this key to determine the operation.
8		MOB/EVENT key	Registers the present position. Pressing and holding down registers the present position to the waypoint and operates the MOB function.
9		GOTO key	Sets the waypoint.

•Reading the Display

RAIM Accuracy level

Display the preset accuracy level

In operation: **10m/30m/50m/100m**

RAIM OFF: "-"

SAFE : No faulty satellite

CAUTION : RAIM impossible

UNSAFE : Presence of fault satellite

Date

Time

U: UTC time

L: Local time

Freeze indicator

During operation, the black part moves. If the black part does not move, the screen freezes.

Geodetic system

Alert icon

This displayed while an alert occurs. For the alert contents, check the alert information.



Beacon information reception display

This is displayed when beacon information has been received.

Alert information

If an alert occurs, alert information is displayed

Arrival

Anchor

XTD

Ex An ALR sentence is received.

D1~D6 Screen number



is pressed, screen is switched.

[S] : Simulation mode

During simulation mode, [S] is blinks

[M] : Equipment mode

During equipment mode, [M] is turned on.

During simulation mode, [M] is turned off.

TR : Route/Track changing function

During route/track changing function, "TR" is turned on.

HDOP Alert display

Displayed when the number exceeds the configured value

Fix mode

3D 3D position fixing

2D 2D position fixing

Position fixing mode

G GPS position fixing

D Beacon DGPS position fixing

Sb SBAS position fixing

noFIX No position fixing

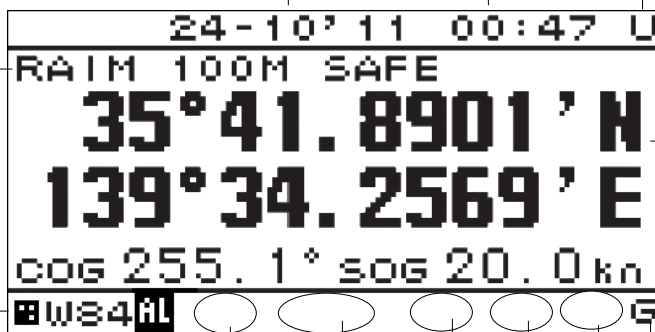

Display area

Status bar

2.2 JLR-4341 DGPS Sensor

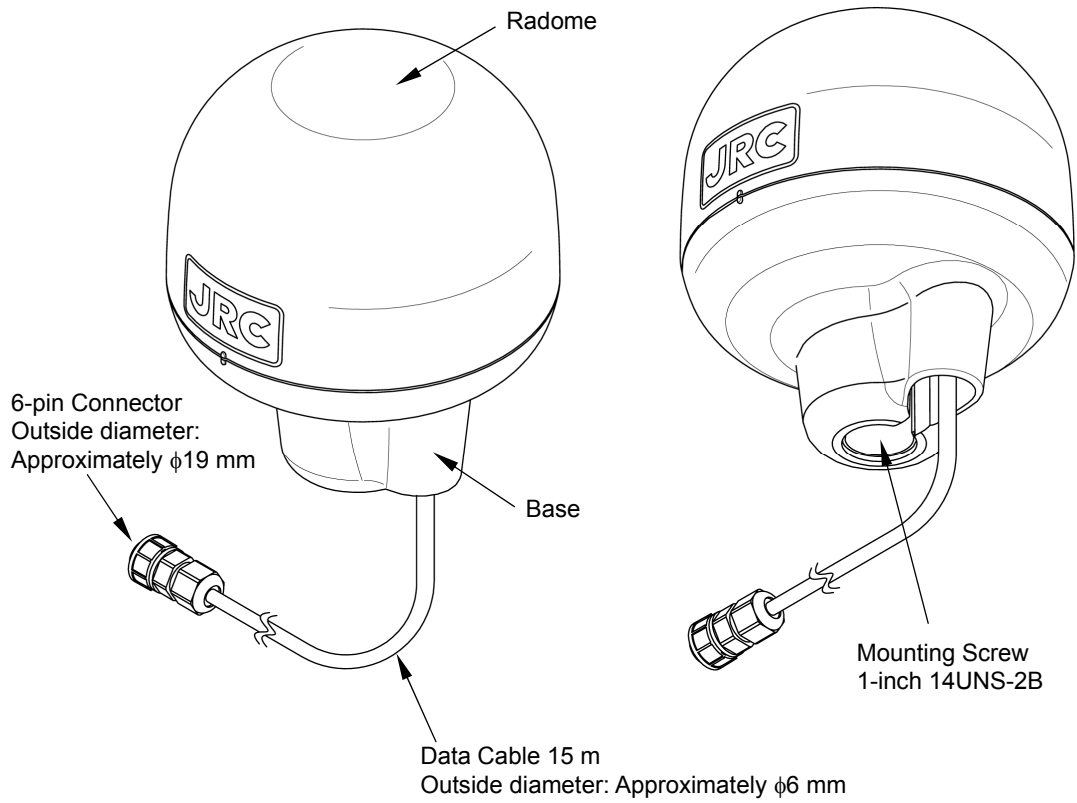

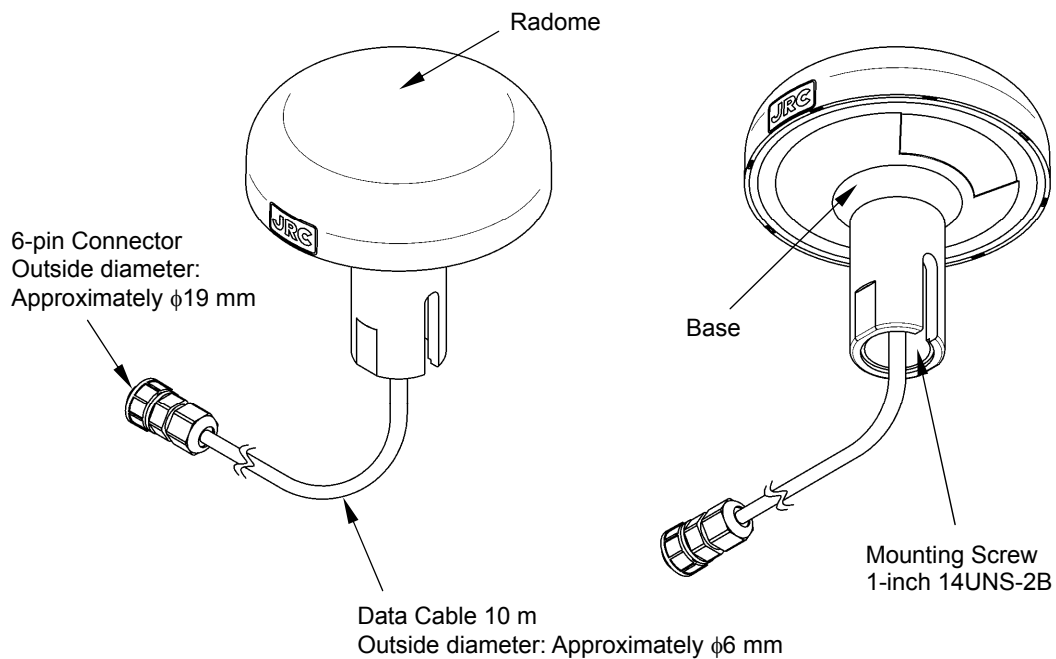

2.3 JLR-4340 GPS Sensor



Section 3 Display Screen

Each screen is detailed in this section.

3.1 Display Screen

The screen is switched each time  is pressed. Users can also determine not to display unnecessary screens. The CDI screen and GPS information screen are provided with sub-screens which can be selected by pressing  .

1) Navigation Screen

This screen displays information such as the own ship's position (Refer to section 2.1 for detail).

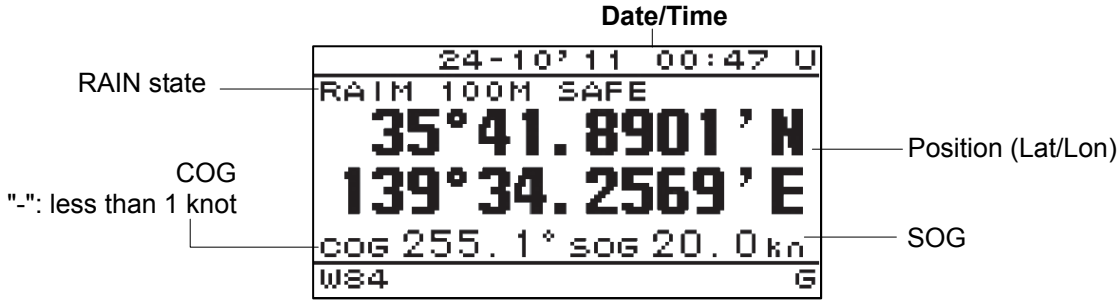

2) PLOT screen

This screen graphically displays the own ship's position

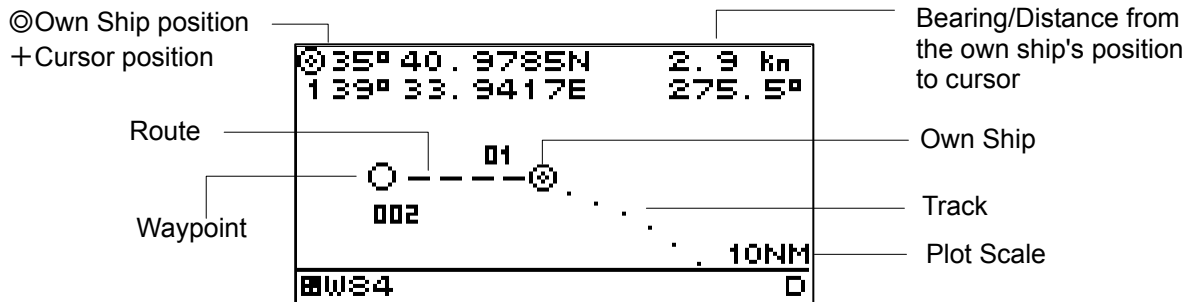

3) GPS information screen

The GPS information screen displays the receiving status of GPS satellites.

Reception information can be displayed by pressing  .

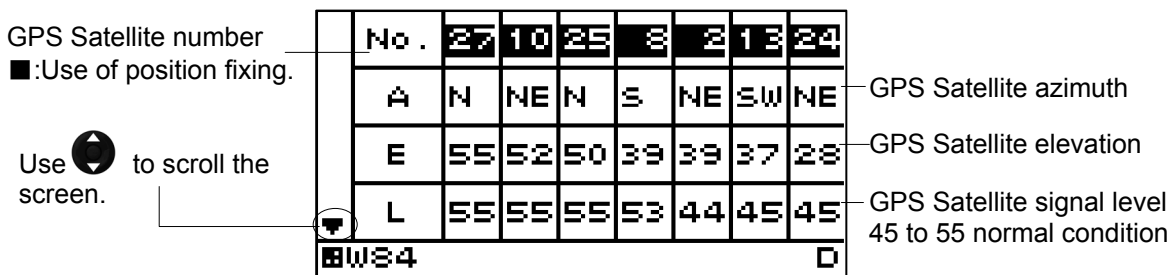

4) Beacon information (Type 16 message) screen

The beacon information screen displays message type 16 information.

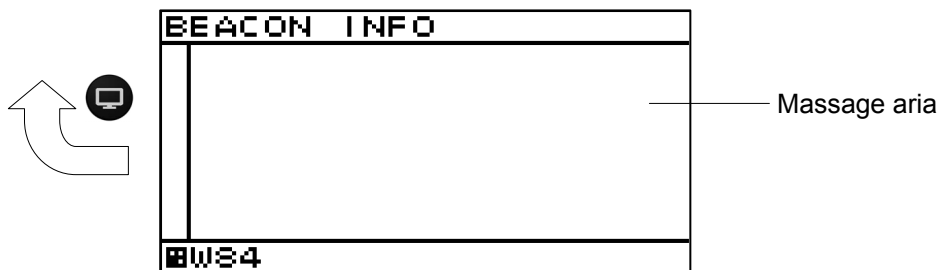

5) CDI screen

Deviation from the route is displayed.

DRG and DTG can be displayed by pressing .

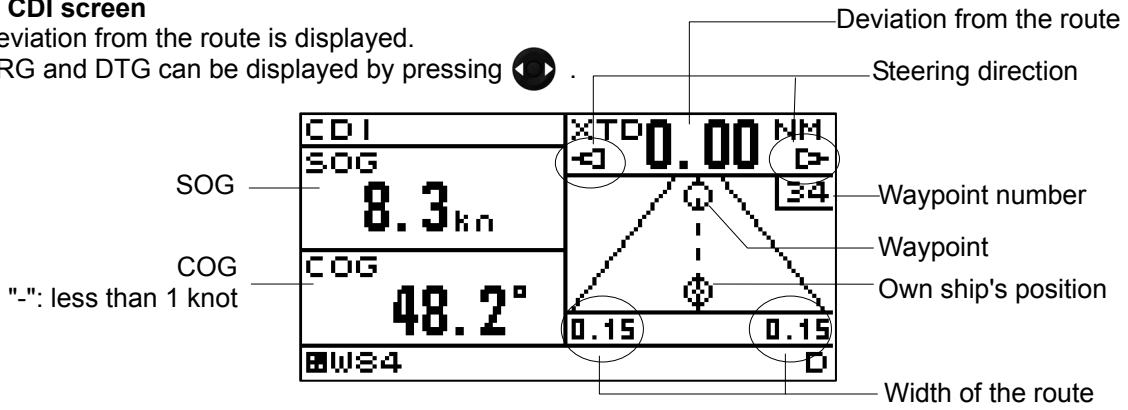

6) Distance (Trip) screen

Trip is displayed. Two trips can be calculated at once.



7) Speed screen

The speed screen can graphically display the speed.

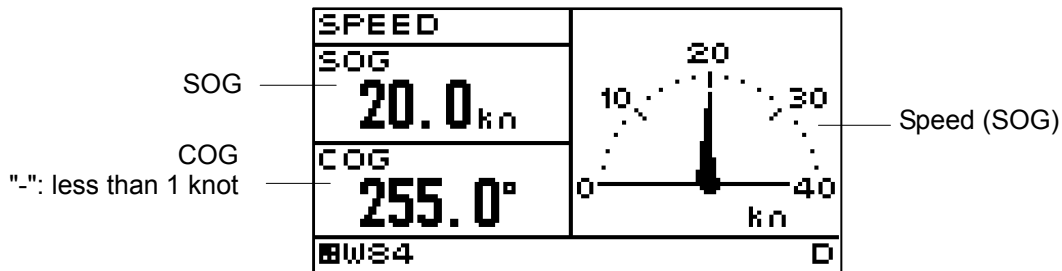

8) Reception information screen

The reception screen can display the beacon information, HDOP, antenna height.

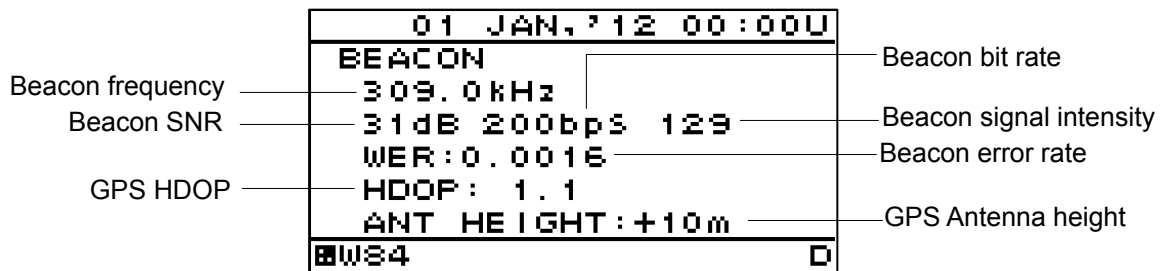

9) Waypoint Information screen

The waypoint screen can display the waypoint number, route number and waypoint position.

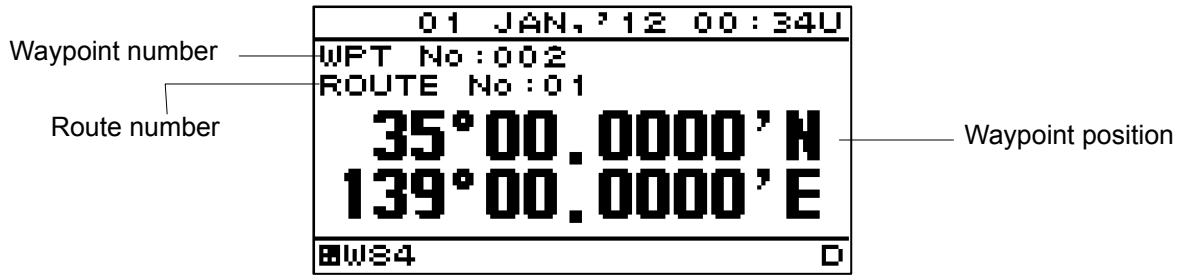

Memo

VTD (Speed of the destination component)

VTD (An acronym of "Velocity Toward Destination")

This is an index that shows how fast the boat is approaching toward the destination in the unit of knot when it is navigating at a given bearing angle and speed.

VEAR (Speed of the COG component)

VEAR (An acronym of "Velocity Along Route")

This is an index that shows how fast the vessel is approaching along the planned route in the unit of knot when it is navigating at a given course and speed.

CMG (Average bearing)

CMG (An acronym of "Course Made Good")

The bearing angle to the current position when viewed from the starting point.

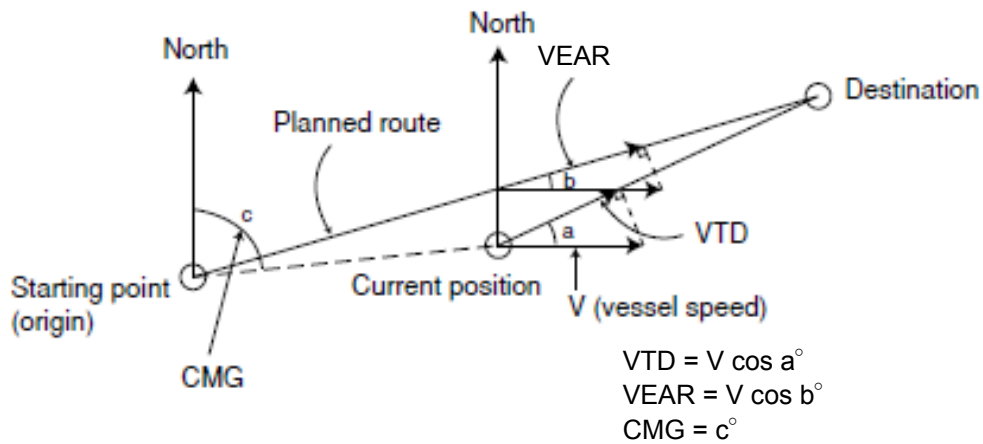

Section 4 Operation

4.1 Menu List

Main Menu	Sub Menu	Range	Note
DISPLAY	LCD		-
	CONTRAST	1-13	4.9.1
	DIMMER MAXIMUM	4-13	4.9.2
	DIMMER TYPICAL	3-12	4.9.2
	DIMMER MINMUM	2-11	4.9.2
	CLICK SOUND	ON/OFF	4.9.3
	DISPLAY SELECTION		4.9.4
	DISPLAY1		4.9.4.1
	SEGMENTATION1		4.9.4.2
	DISPLAY		4.9.4.2
	OWN SHIP	POS※1/COG/SOG	4.9.4.3
	NAVIGATION INFO	XTD/BRG/DTG/TTG/ETA/VTD·VEAR/CMG	4.9.4.3
	OFF		4.9.4.2
	DISPLAY MODE	NORMAL/SPECIAL1/SPECIAL2/AUTO RANGE	4.9.4.3
	AUTO SCREEN	ON/OFF	4.9.4.3
	SOUND	SOUND1/SOUND2/OFF	4.9.4.3
	TIME	1-10sec	4.9.4.3
	SEGMENTATION2		4.9.4.2
	DISPLAY1/2	Same as DISPLAY 1	4.9.4.2
	DISPLAY2/2	Same as DISPLAY 1	5.9.4.2
	AUTO SCREEN	ON/OFF	4.9.4.3
	SOUND	SOUND1/SOUND2/OFF	4.9.4.3
	TIME	1-10sec	4.9.4.3
	SEGMENTATION3		4.9.4.2
	DISPLAY1/3	Same as DISPLAY 1	4.9.4.2
	DISPLAY2/3	Same as DISPLAY 1	4.9.4.2
	DISPLAY3/3	Same as DISPLAY 1	4.9.4.2
	AUTO SCREEN	ON/OFF	4.9.4.3
	SOUND	SOUND1/SOUND2/OFF	4.9.4.3
	TIME	1-10sec	4.9.4.3
	SEGMENTATION4		4.9.4.2
	DISPLAY1/4	Same as DISPLAY 1	4.9.4.2
	DISPLAY2/4	Same as DISPLAY 1	4.9.4.2
	DISPLAY3/4	Same as DISPLAY 1	4.9.4.2
	DISPLAY4/4	Same as DISPLAY 1	4.9.4.2
	AUTO SCREEN	ON/OFF	4.9.4.3
	SOUND	SOUND1/SOUND2/OFF	4.9.4.3
	TIME	1-10sec	4.9.4.3
	SPECIAL		4.9.4.2
	DISPLAY	NAV/BEACON/DISTANCE/WAYPOINT	4.9.4.3
	AUTO SCREEN	ON/OFF	4.9.4.3
	SOUND	SOUND1/SOUND2/OFF	4.9.4.3
	TIME	1-10sec	4.9.4.3
	GRAPHIC		4.9.4.2
	DISPLAY	PLOT/SPEED1/SPEED2/GPS/CDI	4.9.4.3
	AUTO SCREEN	ON/OFF	4.9.4.3
	SOUND	SOUND1/SOUND2/OFF	4.9.4.3
	TIME	1-10sec	4.9.4.3
	OFF		4.9.4.2

※1 POS : Only SEGMENTATION1

Main Menu	Sub Menu	Range	Note
	DISPLAY2	Same as DISPLAY 1	4.9.4.1
	DISPLAY3	Same as DISPLAY 1	4.9.4.1
	DISPLAY4	Same as DISPLAY 1	4.9.4.1
	DISPLAY5	Same as DISPLAY 1	4.9.4.1
	DISPLAY6	Same as DISPLAY 1	4.9.4.1
	BACK LIGHT	WHITE/ORANGE	4.9.5
PLOT	WAYPOINT MARK	○ etc.	4.3.7.1
	EVENT MARK	□ etc.	4.3.7.2
	TRACK PERIOD		4.3.6.1
	TIME	1sec - 60min	4.3.6.1
	DISTANCE	0.01 - 99.99NM	4.3.6.1
	OFF		4.3.6.1
	TRACK ERASE		4.2.6.2
	TRACK TO ROUTE		4.3.8
	TRACK PERIOD		4.3.8
	TIME	1sec - 60min	4.3.8
	DISTANCE	0.01 - 99.99NM	4.3.8
	ROUTE START/END	START/END	4.3.8
WPT/ROUTE	WPT LIST	0-999 LIST DISPLAY	4.4.1
	WPT No		4.4.2
	MARK		4.4.2
	COMMENT		4.4.2
	POSITION		4.4.2
	ENTER		4.4.2
	MAKE ROUTE/LIST	1-20 LIST DISPLAY	4.5.1
	ROUTE No		4.5.2
	RADIUS		4.5.2
	WIDTH		4.5.2
	PLAN SPEED		4.5.2
	GC/RL	GC/RL	4.5.2
	WPT LIST		4.5.2
	ENTER		4.5.2
	ROUTE START/END		4.6.1
	LEG CHANGE	AUTO/MANUAL	4.6.1
	DIRECTION	ORDER/REVERSE	4.6.1
	SPEED SMOOTHING	OFF/1-99sec	4.6.1
	NAVIGATION	START/END	4.6.1
	DELETE WPT		4.4.5
	WPT LIST		4.4.5
	FROM TO		4.4.5
	ALL DELETE		4.4.5
	DELETE ROUTE		4.5.5
	ROUTE LIST		4.5.5
	FROM TO		4.5.5
	ALL DELETE		4.5.5

Main Menu	Sub Menu	Range	Note
SYSTEM	UNIT		4.10.1
	DIST/SPD	NM, kn / km, km/h / mi. mi/h / m, m/s	4.10.1
	ANT HEIGHT	m / ft / fm	4.10.1
	TIME DIFF	-13:00 - +13:30	4.10.2
	DATE DISP	YY-MMM-DD HH:MM/DD MMM,'YY HH:MM/MMM DD,'YY HH:MM	4.10.3
	MAG CORR		4.10.4
	DISPLAY	OFF/AUTO/MANUAL	4.10.4
	OUTPUT	OFF/AUTO/MANUAL	4.10.4
	LORAN C		4.10.5
	LORAN C	ON/OFF	4.10.5
	GRI		4.10.5
	TD1	0 - 99	4.10.5
	TD2	0 - 99	4.10.5
	TD1 CORR	-9.9 - +9.9	4.10.5
	TD1 CORR	-9.9 - +9.9	4.10.5
	DATUM	47 TYPES (Refer to Appendix1)	4.10.6
LANG.	LANG.	English/Japanese/Norwegian/ French/German/Italian/Spanish/ Vietnamese/Indonesian	4.11
ALARM	SYSTEM	ON/OFF	4.12.1
	SOUND	ON/OFF	4.12.8
	LCD	ON/OFF	4.12.8
	SPEED	OVER/UNDER/IN RANG/OUT RANG/OFF	4.12.2
	OVER		4.12.2
	RANGE	0-99.9kn	4.12.2
	SOUND	ON/OFF	4.12.8
	LCD COLOR	ON/OFF	4.12.8
	UNDER		4.12.2
	UNDER	0-99.9kn	4.12.2
	SOUND	ON/OFF	4.12.8
	LCD COLOR	ON/OFF	4.12.8
	IN RANGE		4.12.2
	MAXIMUM	0-99.9kn	4.12.2
	MINIMUM	0-99.9kn	4.12.2
	SOUND	ON/OFF	4.12.8
	LCD COLOR	ON/OFF	4.12.8
	OUT RANGE		4.12.2
	MAXIMUM	0-99.9kn	4.12.2
	MINIMUM	0-99.9kn	4.12.2
	SOUND	ON/OFF	4.12.8
	LCD COLOR	ON/OFF	4.12.8
	TRIP	OVER/OFF	4.12.3
	OVER		4.12.3
	RANGE		4.12.3
	SOUND	ON/OFF	4.12.8
	LCD COLOR	ON/OFF	4.12.8

Main Menu	Sub Menu	Range	Reference/Note
	ARRIVAL/ANCHOR	ARRIVAL/ANCHOR/OFF	4.12.4
	SOUND	ON/OFF	4.12.8
	LCD COLOR	ON/OFF	4.12.8
	XTD	ON/OFF	4.12.5
	SOUND	ON/OFF	4.12.8
	LCD COLOR	ON/OFF	4.12.8
	DGPS	ON→OFF/OFF→ON/OFF⇔ON/OFF	4.12.6
	SOUND	ON/OFF	4.12.8
	HDOP	OVER/OFF	4.12.7
	OVER	1 - 20	4.12.7
	SOUND	ON/OFF	4.12.8
	LCD COLOR	ON/OFF	4.12.8
SENSOR	GPS MODE	AUTO/GPS ALONE/ BEACON/SBAS	4.13.1
	FIX MODE	AUTO/2D/3D	4.13.2
	ELV MASK	5-89deg	4.13.3
	HDOP	4/10/20	4.13.4
	SMOOTHING		4.13.5
	POSITION	0-99sec	4.13.5
	SPEED	0-99sec	4.13.5
	COURSE	0-99sec	4.13.5
	RAIM ACCURACY	OFF/10/30/50/100m	4.13.6
	INITIALIZATION		4.13.7
	LATITUDE		4.13.7
	LONGITUDE		4.13.7
	HEIGHT		4.13.7
	DATE		4.13.7
	TIME		4.13.7
	SEND		4.13.7
	BEACON		4.13.8
	STATIO SELECT	AUTO/MANUAL	4.13.8
	FREQUENCY		4.13.8
	BIT RATE	50/100/200 bps	4.13.8
	SBAS		4.13.9
	SBAS SEARCH	AUTO/ MANUAL Selection	4.13.9
	TYPE 0 INFO	ON/OFF	4.13.9
	RANGING	ON/OFF	4.13.9
BEACON	DISPLAY	ON/OFF	4.14.1

Main Menu	Sub Menu	Range	Reference/Note
INTERFACE	DATA I/O		4.15.5
	DATA IN/OUT1	NMEA/JRC/IEC	4.15.5
	NMEA		4.15.5
	DATA IN/OUT	SEND/RECEIVE	4.15.5
	VERSION	1.5/21./2.3/4.0	4.15.5 SEND Only
	SENTENCE	SENTENCE LIST	4.15.5 SEND Only
	BIT RATE	4800/9600/19200/38400	4.15.5
	IEC		4.15.5
	DATA IN/OUT	SEND/RECEIVE	4.15.5
	BIT RATE	4800/9600/19200/38400	4.15.5
	SENTENCE	SENTENCE LIST	4.15.5 SEND Only
	JRC		4.15.5
	INTERVAL	OFF/4s	4.15.5
	DATA IN/OUT2	NMEA/JRC/IEC/ROUTE WPT	4.15.5
	NMEA		4.15.5
	DATA IN/OUT	SEND/RECEIVE	4.15.5
	VERSION	1.5/21./2.3/4.0	4.15.5 SEND Only
	SENTENCE	SENTENCE LIST	4.15.5 SEND Only
	BIT RATE	4800/9600/19200/38400	4.15.5
	IEC		4.15.5
	DATA IN/OUT	SEND/RECEIVE	4.15.5
	BIT RATE	4800/9600/19200/38400	4.15.5
	SENTENCE	SENTENCE LIST	4.15.5 SEND Only
	JRC		4.15.5
	INTERVAL	OFF/4s	4.15.5
	ROUTE WPT		4.15.5
	VERSION	1.5/2.1/2.3/4.0/JRC	4.15.5
	BIT RATE	4800/9600/19200/38400	4.15.5
	OUTPUT DATA	ALL WAYPOINT/ALL ROUTE/ ALL WAYPOINT+ROUTE/ ALL TRACK	4.15.5
	SEND		4.15.5
	DATA IN/OUT3	NMEA/JRC/IEC/ROUTE WPT	4.15.5
	NMEA		4.15.5
	DATA IN/OUT	SEND/RECEIVE	4.15.5
	VERSION	1.5/21./2.3/4.0	4.15.5 SEND Only
	SENTENCE	SENTENCE LIST	4.15.5 SEND Only
	BIT RATE	4800/9600/19200/38400	4.15.5
	IEC		4.15.5
	DATA IN/OUT	SEND/RECEIVE	4.15.5
	SENTENCE	SENTENCE LIST	4.15.5 SEND Only
	BIT RATE	4800/9600/19200/38400	4.15.5
	JRC		4.15.5
	INTERVAL	OFF/4s	4.15.5
	ROUTE WPT		4.15.5
	BIT RATE	4800/9600/19200/38400	4.15.5
	RECEIVE		4.15.5
	RS-485		4.15.4
	NMEA		4.15.4
	VERSION	1.5/21./2.3/4.0	4.15.4
	SENTENCE	SENTENCE LIST	4.15.4
	BIT RATE	38400/57600/76800/115200	4.15.4
	IEC		4.15.4
	BIT RATE	38400/57600/76800/115200	4.15.4
	SENTENCE	SENTENCE LIST	4.15.4
	CONTACT INPUT	DIMMER/ACK	4.15.6
	CONTACT OUTPUT	200PLUSE/NM/400PLUSE/NM /ALARM/OFF	4.15.7
	DIAGNOSIS	CONFIG OUT/ ERROR LOG OUT	4.15.14/4.15.8

Main Menu	Sub Menu	Range	Reference/Note
MAINTENANCE	INPUT DATA		4.15.9.1
	DIAGNOSIS		4.15.9.2
	DISPLAY DIAG		4.15.9.2
	SENSOR DIAG		4.15.9.2
	MONITOR TEST		4.15.9.2
	BUZZER TEST		4.15.9.2
	ERROR LOG		4.15.9.3
	ALARM		4.15.9.3
	ERROR LOG		4.15.9.3
	SOFT VERSION		4.15.9.4
	DISPLAY VER		4.15.9.4
	APP VER		4.15.9.4
	SERIAL NUMBER		4.15.9.4
	BARCODE		4.15.9.4
	SENSOR VERSION		4.15.9.4
	APP VER		4.15.9.4
	SERIAL NUMBER		4.15.9.4
	BAECODE		4.15.9.4
MASTER RESET	DISPLAY RESET		4.15.10
	DISPLAY		4.15.10
	EXCEPT FOR LIST		4.15.10
	RECEIVER RESET		4.15.10
	ALL RESET		4.15.10
DEMO MODE	DEMO TYPE	STATIC/STRAIGHT/RIGHT/LEFT/ROUTE/AUTO	4.15.11
	DATE		4.15.11
	TIME		4.15.11
	LATITUDE		4.15.11
	LONGITUDE		4.15.11
	DEMO MODE	START/END	4.15.11
SOFT UPDATE	DISPLAY		-
	SENSOR		-
MAIN/SUB		MAIN/SUB	4.15.12
RECEIVER No		1/2	4.15.13
DISPLAY TYPE		MID/LOG/GPS/OFF	4.15.2 OFF factory setting
RS-485ID		1-10	4.15.4.1
DIMMER GROUP		1-10	4.15.4.3
DIMMER		KEY/EXT DIMMER	4.15.3
CCRP	BEAM	1.0-70.0m	4.15.15
	LENGTH	1.0-700.0m	4.15.15
	SENSOR X	-35 ~+35m	4.15.15
	SENSOR Y	0-700.0m	4.15.15
	SENSOR Z	-10~100.0m	4.15.15
	CCRP X	-35 ~+35m	4.15.15
	CCRP Y	0-700.0m	4.15.15
	CCRP Z	-10~100.0m	4.15.15

4.2 Basic Operation

4.2.1 Turning the Unit On

When the main power is turned on, the power to the display unit is automatically turned on.

In the state in which the power is turned off by the display unit key operation, pressing the  key turns on the power.

When the main power is OFF.

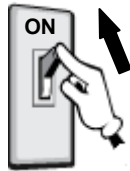

Turning on the main power.

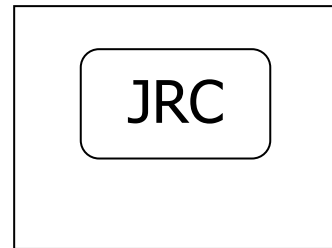
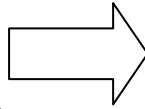

Opening Screen

When the main power is ON.



Pressing the Power key

When the power is ON for first time.

The following screen is displayed. Select a Model with  and press .



Model

When "LOG" is selected by mistake

Refer to "Caution" in "4.15.2 setting a model".

Supplement

If the power cannot be turned on, check the main power of the power distribution board and the cable connection to the display unit.

When "GPS" is selected by the first time power up and model setup for the prevention from receiver breakage, the check of a receiver and display power supply voltage is performed.

Use a receiver and the display power supply voltage in the following combination.

Receiver	Display power supply voltage
JLR-4341/4340	DC12~24V
except JLR-4341 / 4340	DC12V

1. A receiver is selected.
Select the receiver connected.

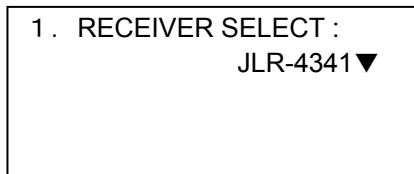

When JLR-4341/4340 are selected by mistake, turn OFF a power immediately and carry out action 1.
When selected except JLR-4341/4340 by mistake, turn OFF a power and carry out power ON again.

2. When receivers except JLR-4341/JLR-4340 are selected, perform a power supply check.

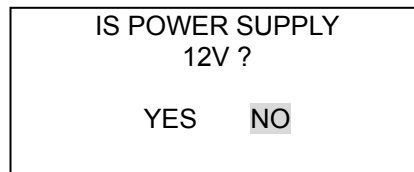

When DC24V is supplied to the display, select NO and exchange power supplies to 12V.
When YES is selected by mistake, turn OFF a power supply immediately and exchange power supplies to 12V.
Moreover, **do not carry out power supply ON until it exchanges a power supply for 12V.**
A receiver will be damaged if DC24V is supplied to a receiver.

If NO is selected

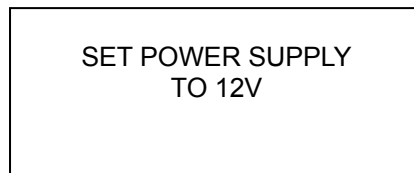

Since the above is displayed, turn OFF a power supply.
Exchange the power supply of a display for 12V. If a power is turned ON again, it will operate from a receiver selection screen.

Action 1

- 1) Pull out a receiver cable and turn ON a power.
- 2) Select "GPS" by model setup again with reference to "4.15.2 Model setup is performed."
- 3). Connect a receiver cable and carry out from receiver selection.

Warning

- In this display, the voltage supplied to the display is supplied to a receiver as it is.
When you use receivers except JLR-4341/JLR-4340, set the power supply of a display to DC12V.
Supply of 24V will damage a receiver.

4.2.1.1 Startup (Standard)

If all the self-check results are 'OK', the screen is automatically changed to the normal screen.

```
SELF DIAGNOSING...
ROM CHECK:OK
RAM CHECK:OK
SC10 CHECK:OK
SC11 CHECK:OK
SC12 CHECK:OK
SC13 CHECK:OK
SC16 CHECK:OK
```



```
NAVI 24-10'11 00:47 U
RAIM 100M SAFE
35°41.8901' N
139°34.2569' E
COG 255.1° SOG 20.0kn
WS4 G
```

4.2.1.2 Startup (Error-1)

If the self-diagnosis results are errors "NG," the results are displayed as follows.

```
ALARM
ROM [2]
OK
```

Supplement

When any abnormality (NG) is found, contact JRC or one of our agents.

4.2.1.3 Startup (Error-2)

Messages shown below may be displayed during sensor diagnostics.

The message appears when display unit and sensor configuration settings do not match, such as when equipment has been replaced.

When this occurs, select one of the items, and press the  key to perform it.

```
DISPLAY COFIG IS
DIFFERENT FROM
SENSOR
SENSOR DISPLAY
```

[SENSOR]: Replaces display configuration with the sensor configuration.

[DISPLAY]: Replaces the sensor configuration with the display configuration.

Supplement



Consult with JRC or its affiliate if this is displayed frequently.

4.2.1.4 Startup (Error-3)

When the program is corrupted, the following screen is displayed. Turn off the power and contact JRC or one of our agents.

```
R0004
Recovery
mode.
```

4.2.2 Turning off the power

If the  key and the  key are pressed and held down simultaneously, the power will be turned off and the screen display will turn off.



Supplement

The power may be turned on due to the release timing of your finger.

In this case, first release the  and then release the .

4.2.3 Adjusting the Backlight by using the kry

The brightness of display and operation panel backlight can be set to one of four levels (bright, medium, dark, off).

Whenever  is pressed, the level changes in the order of bright – medium – dark – off – dark – medium – bright.

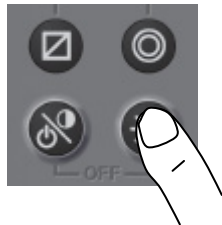

Supplement

- The brightness levels other than “off” can be set. See “4.9.2 Adjusting the back light”.
- An external dimmer unit can also be used for adjusting brightness. See “4.15.3 Selecting a dimmer unit”.

4.2.4 Adjusting contrast

Contrast can be adjusted over 13 levels.

Whenever  is pressed, the contrast is reduced (or increased) from the current setting and after the contrast reaches the lowest (or highest) level, the contrast increases (reduces) gradually.



4.2.5 Turning off the buzzer



Buzzer sound can be turned off by pressing  .
The buzzer sounds if an error occurs.

4.2.6 Switching display

The display screen is switched whenever  is pressed.

4.2.7 Alert display

When an alert occurs, the event is notified with a popup menu and alert sound.

When  is pressed, the popup menu is cleared and the buzzer sound stops. However, display of  remains on the status bar unless the alert is cancelled.



Even after the popup menu is cleared and the buzzer sound is stopped, the invalid numerical number keeps blinking until the alert is cancelled.

To check the alert again after clearing the popup menu, display the alert history by referencing “4.15.9.3 Displaying an alert”

4.2.8 Selecting items from the menus





This section shows the procedure for selecting items from the menus and determining the selection.

Procedure

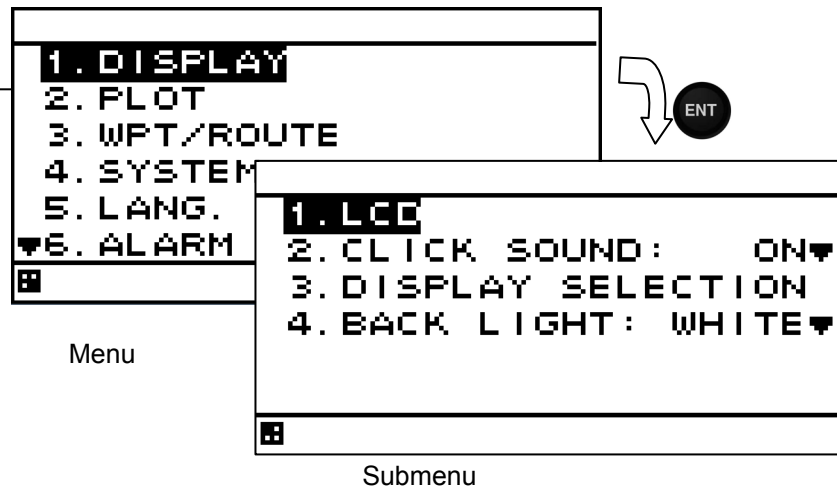

1. Press .
2. Move the cursor to a required item by using  and press . The item is selected and a submenu is opened to enable selection of details.

The selected item is displayed in reverse video.

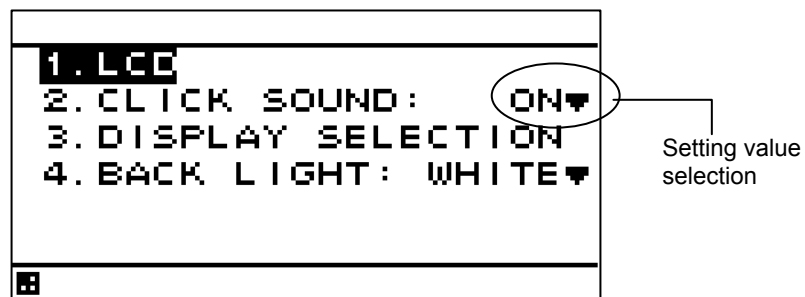

3. Move the cursor to a required item by using  and press . The cursor moves to the setting value selection.
4. Select a setting value with  and press  or . The setting value is confirmed.



5. To return to the previous item, press  or .







Supplement

Power must not be off for 10 seconds after setting. When not doing so, the setting value may not be saved.

4.2.9 Entering a numeric value

This section describes the procedure for entering a numeric value.

Procedure

1. Move the cursor to the field in which a value is to be entered by using .
2. Set a numeric value to be entered by using  and press  or .
3. Move the cursor to the right most field and press  or . The setting value is confirmed.

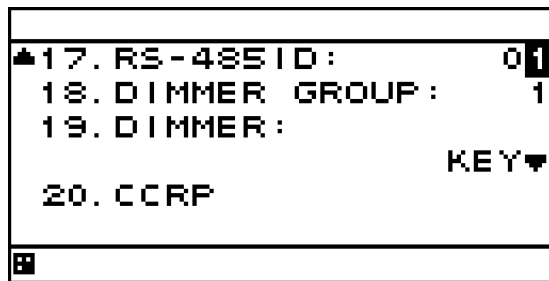

Select a field by using 

Select a numeric value by using 

Supplement

If the numeric value that can be entered is restricted by an input range, enter the digits from the highest order.

To prevent the value from exceeding the input range, the input of the low-order digits is restricted by the value of the high-order digit.

Example) The input range is from 1 to 10:

If 1 is input in the high-order digit, only 0 can be set as the low order digit.

Power must not be off for 10 seconds after setting. When not doing so, the setting value may not be saved.

4.3 Plot Screen Operation

The plot screen can display own ship's position, track, active route, waypoint and cursor information. Display is fixed to North Up.

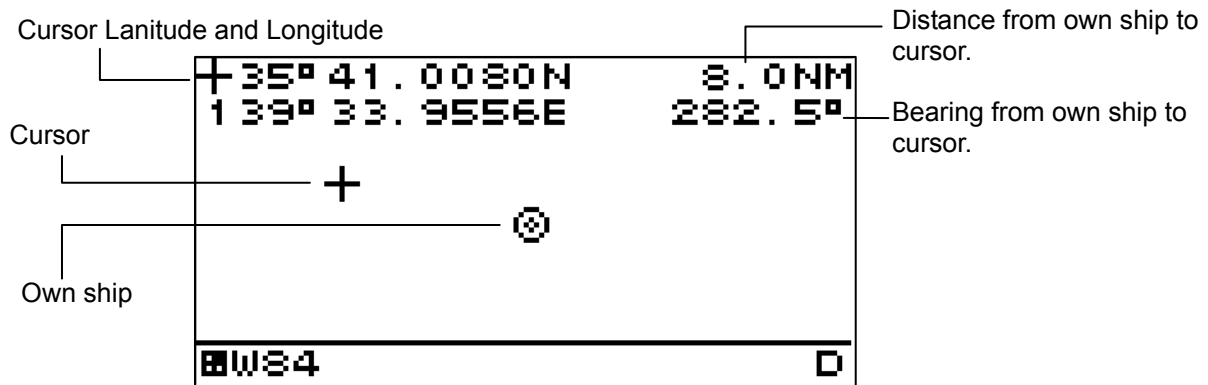

4.3.1 Cursor Operation

4.3.1.1 Displaying the Cursor

- When the  key is pressed, the cursor is displayed.
- When the cursor is displayed, cursor information (cursor latitude and longitude, bearing and distance from own ship to cursor) will be displayed on the screen.

Procedure

1. Press the  key on the plot screen to display the cursor at the center of the screen.
When the cursor is not operated for 5 seconds, cursor display is automatically turned off.

4.3.1.2 Moving the Cursor

- The cursor can be moved up, down, right and left.



Procedure

1. Use the  to move the cursor up, down, right and left.

4.3.2 Zooming the Screen In and Out

- The plot screen width can be set to any of the widths below.
0.125, 0.25, 0.5, 1.0, 2.0, 5.0, 10.0, 20.0, 50.0, 100.0[NM]

Procedure

1. When the cursor is displayed, wait until it disappears.
2. Press the  key to display "SCALE".
The present scale is displayed on the lower right of the screen.
3. Press the  key to change the scale
4. Press the  key. The scale is decided and disappear.

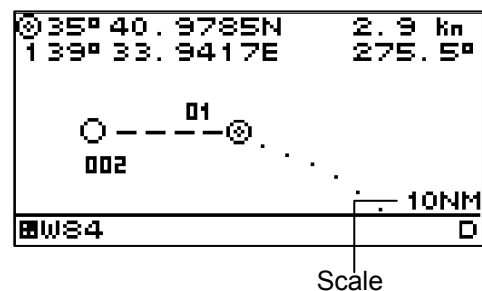

4.3.3 Centering the Own Ship on the Screen

- The position of the own ship can be moved to the center of screen.

Procedure

1. Press the **CLR** key.

Own ship will be displayed at the center of the screen.

Supplement

- When own ship reaches the edge of the screen, it automatically returns to the center of the screen.
- While the temporary route is created, the own ship will not return to the center of the screen even if the **CLR** key is pressed.

4.3.4 Registering the cursor position

The cursor position can be registered to the waypoint list.

Procedure

1. Press the **Cursor** key on the plot screen to display the cursor
2. Press the **ENT** key at the position you wish to register.

4.3.5 Registering the Own ship's position

The own ship's position can be registered to the waypoint list.

Procedure

1. Press the **Own Ship** key.

4.3.6 Track Display

- The own ship's track can be displayed.
- A maximum of 2,000 points of track can be stored. Once this number is exceeded, older track points will be automatically deleted.

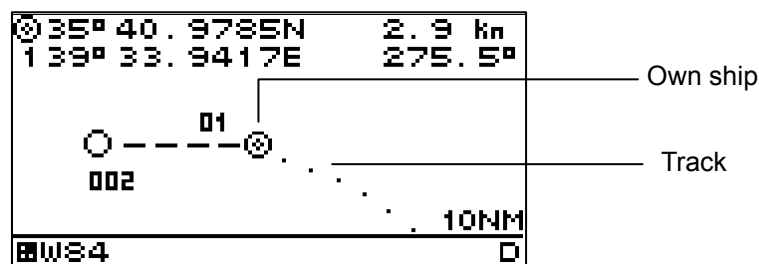

4.3.6.1 Setting the Track Period







Memory intervals can be set to units of time or of distance.

The following periods can be set:

Time: Can be set in 1 second increments between 1 second to 60 minutes.

Distance: Can be set in 0.01 NM increments between 0.01 to 99.99 NM.

Procedure

1. Press the  key to display the main menu.
2. Press the  key to select "PLOT" and "TRACK PERIOD" and press the  key.
3. Press the  key to select "TIME" or "DISTANCE" and press the  key.
4. Press the  key to enter the period.

Supplement



- If the period is set to "OFF," track memory will be deactivated. Previously stored data will be retained.

4.3.6.2 Deleting Tracks

All tracks can be deleted.

Partial deletion cannot be performed.

Procedure

1. Press the  key to display the main menu.
2. Press the  key to select "PLOT" and "TRACK ERASE" and press the  key.
3. When the following popup is displayed, press "YES".

DELETE OK?
YES NO

4.3.7 Waypoint Symbol and Route Display



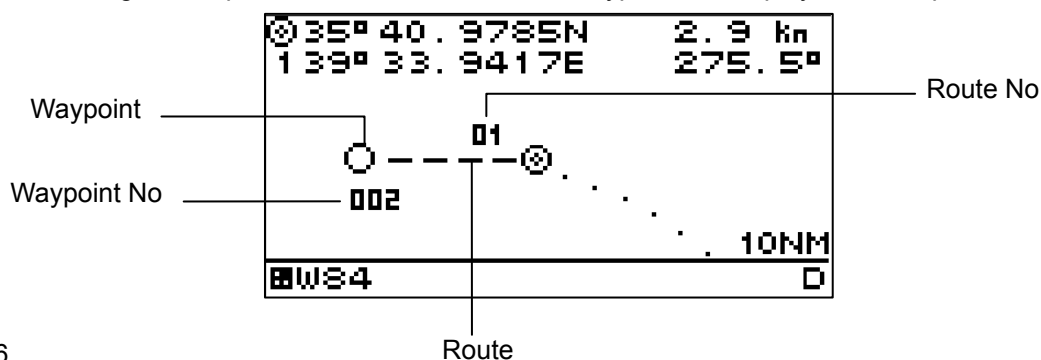

- The symbols and numbers of waypoints registered in the waypoint list are displayed on the plot screen.
- When navigation is performed, the route and the waypoint are displayed on the plot screen.



4.3.7.1 Changing Waypoint Symbol

- Set the default value of the symbol to be displayed for the waypoint.
- The symbol can also be changed individually from the waypoint list.
- In order to change symbols, you must switch the unit to non-IMO mode.





Procedure

1. Press the  key to display the main menu (standard mode).
2. Use the  key to select "PLOT" and "WAYPOINT MARK" and press the  key.
3. Use the  key to select the symbol and press the  key.

4.3.7.2 Changing Event/Mark Symbol



- Set the default value of the symbol to be displayed for the event/mark.
- The symbol can also be changed individually from the waypoint list.
- In order to change symbols, you must switch the unit to non-IMO mode.

Procedure



1. Press the  key to display the main menu (standard mode).
2. Use the  key to select "PLOT" and "EVENT MARK" and press the  key.
3. Use the  key to select the symbol and press the  key.

Supplement

To switch to non-IMO mode

1. Display a PLOT screen
2. Press the  and  for 8 second. "NON IMO" pop-up appears for 3 second.

To switch to IMO mode again

1. Display a PLOT screen
2. Press the  and  for 8 second. "IMO" pop-up appears for 3 second.

4.3.7.3 Deleting Event/Mark Symbols

The registered events/marks must be deleted from the waypoint list to delete them. To delete events/marks from the waypoint list, refer to "4.4.5 Deleting waypoints."

4.3.8 Changing Route into Track

A track can be registered into a destination list, and it can change into a route.

Registration interval which registers a track into a destination list:

Time: It can set up by one second bit in 1 second - 60 minutes.







Distance: It can set up by 0.01NM bit in 0.01NM - 99.99NM.

By pressing the event key , arbitrary positions can be registered during route/track changing function operation.

When stopping a route/track function, a route is created by the registered destination.

During route/track execution, the "TR" icon is displayed under the screen.

Procedure

1. Press the  key to display the main menu (standard mode).
2. Press the  key to select "PLOT", "TRACK TO ROUT" and "TRACK PERIOD" and press the  key.
3. Press the  key to select "TIME" or "DISTANCE" and press the  key.
4. Press the  key to enter the memory interval.
5. Press the  key to select "ROUTE START/END" and select "START".
6. When stopping the rout/track changing function, select "END"

Supplement

- During route/track changing function execution, it continues registering with a destination list at intervals of registration. Select a registration distance so that a destination list does not become full.
- When a destination list becomes full, registration of subsequent track cannot be performed.
- Route creation cannot be performed when a route list is full.

4.4 Registering Waypoints

- Waypoints must be registered to the waypoint list to start navigation.
- Up to 1,000 waypoints can be registered in this unit.

4.4.1 Displaying the Waypoint List

The registered waypoints can be displayed.

The waypoint number 000 is only for a MOB position. Even if the MOB position is not registered, 000 displays.



It is convenient to register waypoint number 001 as "HOME PORT."

When registering the waypoint, a waypoint number and the registered comment are displayed.

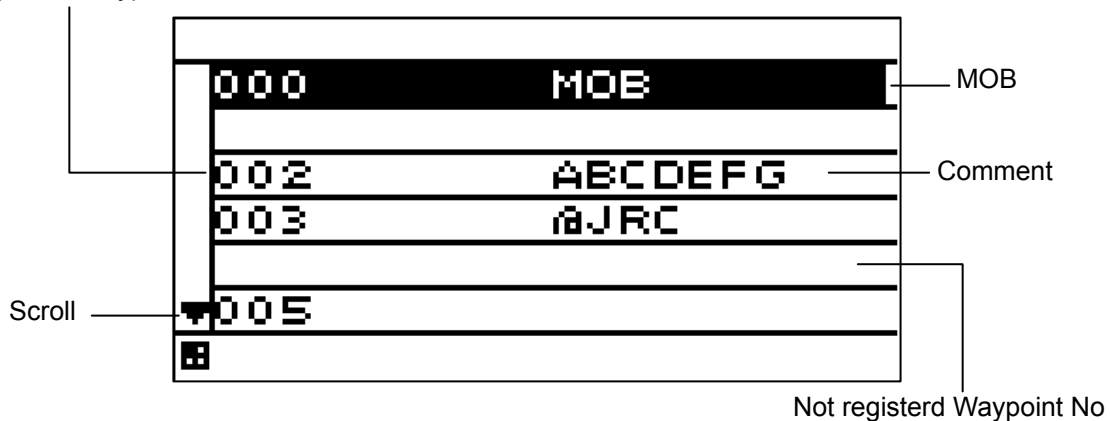
Registered Waypoint No



Procedure

1. Press the  key to display the main menu.
2. Press the  key to select "WPT/ROUTE" and "WPT LIST" and press the  key.

Supplement

- The position registered as HOME in the waypoint list can be easily set as the waypoint using the GOTO function.
It is convenient to register a frequently used waypoint (such as the home port) as HOME.
Refer to "4.6.2 Selecting a Waypoint/Route with the GOTO Key" for a GOTO function.

4.4.2 Registering Waypoints



The following three positions can be registered in the waypoint list. Up to 1,000 waypoints can be registered.

- (1) Own ship position
- (2) Specified latitude and longitude
- (3) Position defined by a bearing and distance from a specified position

To register, first display the waypoint registration screen.

Procedure

1. Press the  key to display the main menu.



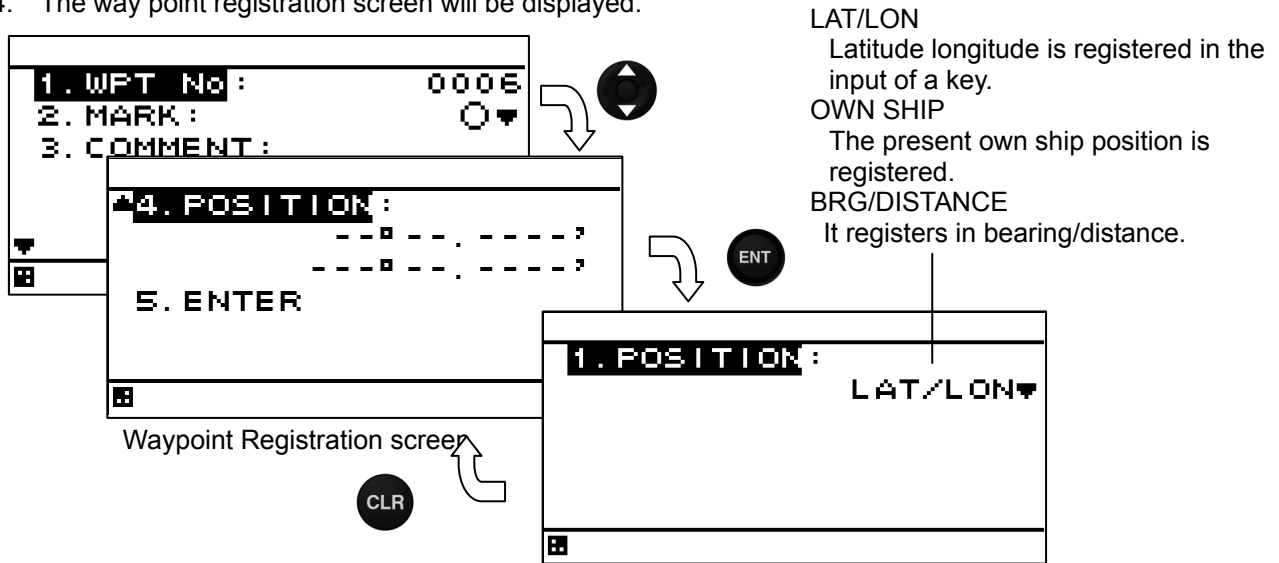

2. Press the  key to select "WPT/ROUTE" and "WPT LIST," and press the  key.
3. Move the cursor to the number you wish to register, and press the  key.
4. The way point registration screen will be displayed.



4.4.2.1 Registering the Own Ship Position

The own ship position can be registered in the waypoint list.







Procedure

1. Refer to "4.4.2 Registering Waypoints" and display the waypoint registration screen.
2. Press the  key to select "POSITION", "OWN SHIP" and press the  key.
3. The own ship position is shown in "LAT" and "LON."
4. Press the  key to select "ENTER" and press the  key.

4.4.2.2 Registering Latitude and Longitude

Any latitude and longitude can be registered in the waypoint list.

Procedure

1. Refer to "4.4.2 Registering Waypoints" and display the waypoint registration screen.
2. Press the  key to select "POSITION", "LAT/LON" and press the  key.
3. Press the  key to enter "LATITUDE", "LONGITUDE" and press the  key.
4. Press the  key to select "ENTER" and press the  key.



4.4.2.3 Registering a Bearing and Distance from a Specified Position

A position can be specified as a start point, and then another position defined by its bearing and distance from said start point can be registered in the waypoint list.

A start point can be selected from the following three items.

- (1) Specified Latitude/Longitude: Select "LAT/LON."
- (2) Own Ship Position: Select "OWN SHIP."
- (3) Position Registered in Waypoint List: Select "WPT No."

Procedure

1. Refer to "4.4.2 Registering Waypoints" and display the waypoint registration screen.
2. Press the  key to select "POSITION", "BRG/DISTANCE."
3. Press "START POINT," press the  key to select the start point, and press the  key.

(1) When "LAT/LON" is selected



4. Enter "LATITUDE" and "LONGITUDE", and press the  key.



(2) When "OWN SHIP" is selected



4. The own ship position is shown in "LAT" and "LON."

(4) When "WPT No" is selected

4. The waypoint list will be displayed. Move the cursor to the position you wish to use as the start point, and press the  key.



5. Press the  key to enter "BRG" and press the  key.

6. Press the  key to enter "DISTANCE" and press the  key.

7. Press the  key to select "ENTER," and press the  key.

The latitude and longitude of the waypoint calculated from the start point, and will be displayed.

8. Press the  key to back to the waypoint registration screen





9. Press the  key to select "ENTER," and press the  key.

The waypoint position is registered.

4.4.3 Editing Waypoint Information

- Registered waypoint information (symbol shape, comment, waypoint position) can be edited.
- Waypoints on routes that are currently being executed cannot be edited.

Procedure

1. Press the  key to display the main menu.
2. Press the  key to select "WPT/ROUTE" and "WPT LIST" and display the waypoint list.
3. Press the  key to move the cursor to the waypoint number you wish to edit, and press the  key.
4. The waypoint registration screen will be displayed.

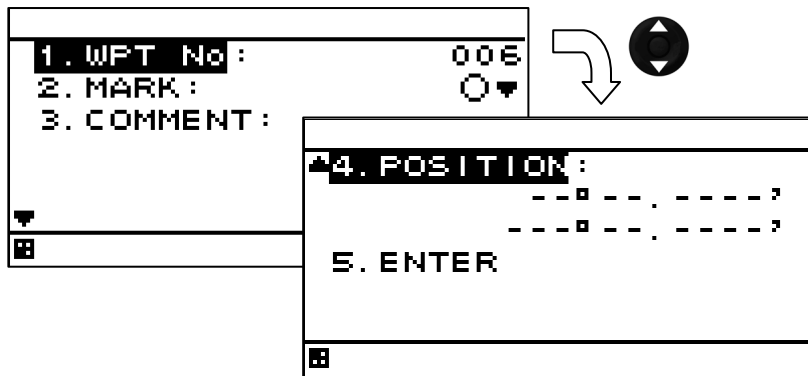

Waypoint Registration screen



(1) To edit the waypoint number

5. Select "WPT No."
6. Press the  key to enter the waypoint number.

The same information is entered in the input waypoint number. Information about the waypoint number before change also remains.

Delete the destination with reference to "4.4.5 Deleting Waypoints" to delete the information before change.



(2) To edit the symbol shape

7. Select "MARK."
8. Press the  key to select the shape, and press the  key.

(3) To edit a comment

9. Select "COMMENT" and enter the comment.

(4) To edit waypoint position "LAT/LON"

10. Select "POSITION," and enter the waypoint position.
Refer to "4.4.2 Registering Waypoints" for details on how to enter the waypoint position.
11. Press the  key to select "ENTER" and press the  key.





4.4.4 Copying Waypoint Information

- To copy waypoint information to another waypoint number, use the number to which the information is to be copied as the waypoint number in waypoint information. The source information is not deleted but is copied.
Please refer to "4.4.3 Editing waypoint information (1) To edit the waypoint number" for details.

4.4.5 Deleting Waypoints

- Registered waypoints can be deleted.
- Waypoints on routes that are currently being executed cannot be deleted.
- When a waypoint on a route that is not currently being executed is deleted, it will be deleted from the route as well.

Procedure

- Press the  key to display the main menu.
- Press the  key to select "WPT/ROUTE" and "DELETE WPT" and display the waypoint list.
- Press the  key to select the waypoint to be deleted, and press the  key.



An overview of the delete waypoint submenu is as follows.

- WPT LIST: Specify the waypoint number to be deleted from the waypoint list.
- FRON TO: Enter the start and end points, and specify the range to be deleted.
- ALL DELEATE: Delete all waypoints from 1 to 999.

(1) When "WPT LIST" is selected

The waypoint list will be displayed. Press the  key to specify the waypoint number to be deleted, and press the  key.

(2) When "FROM TO" is selected

Enter the waypoint numbers at start ("FROM") and end ("TO") points.

Press the  key to select "DELETE WPT" and press the  key.

(3) When "ALL DELEATE" is selected

All waypoints will be deleted.

- When the following popup is displayed, press "YES".

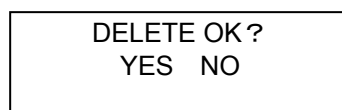

4.5 Route Planning

- Routes can be created using the registered waypoints.
- A maximum of 20 routes can be created with this unit, with each route having up to 50 waypoints.
- Arrival circle radii, route widths, planned speed and distance calculation method can be set for each route.

4.5.1 Displaying the Route List



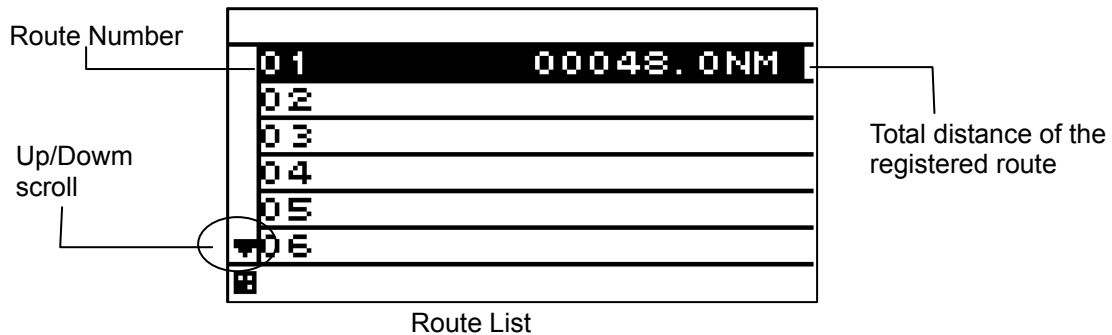

The created routes can be displayed in the route list.

The total distance is displayed in the registered route number.

The required time cannot be calculated for routes for which no planned speed has been set.





Procedure

1. Press the  key to display the main menu.
2. Press the  key to select "WPT/ROUTE" and "MAKE ROUTE/LIST," and press the  key.
3. Move the cursor to the route number you wish to display, and press the  key.

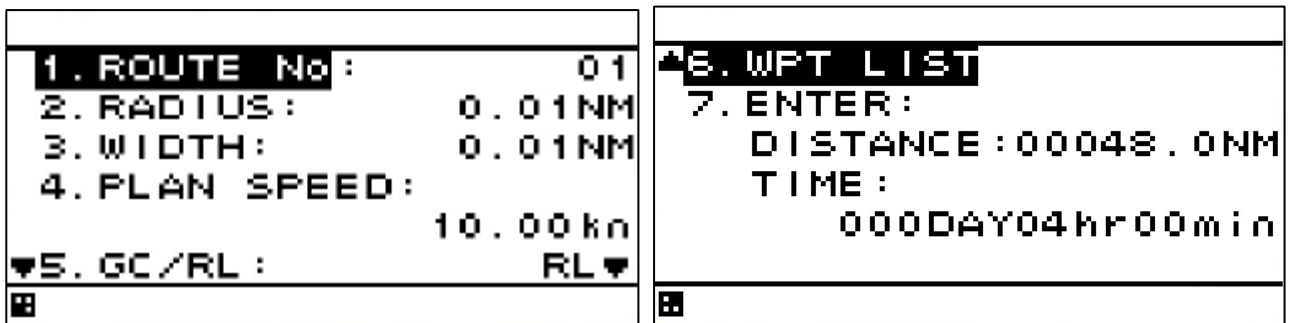
On the Route information screen, arrival circle radius, route width, planned speed, distance calculation method (GC/RL) and route waypoints are displayed.



Route information screen

4. Press the  key to select "WPT LIST" and press the  key.

The route waypoints are listed

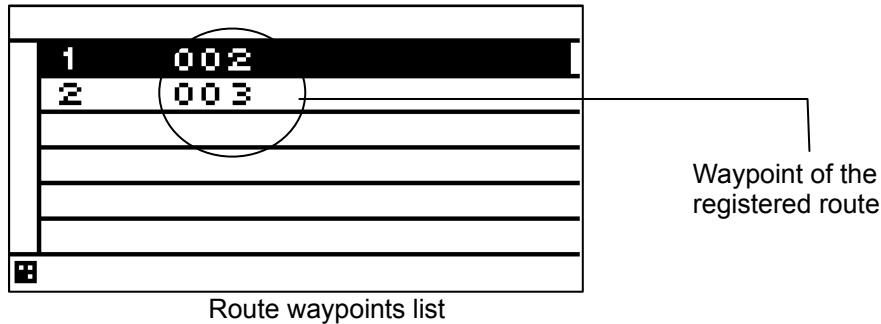

4.5.2 Creating Routes

- To create a route, decide the route number and select the waypoints to be used as way points in order.
- The same waypoint cannot be selected in a continuous manner.
- Up to 20 routes can be created.
- Up to 50 waypoints can be set on each route.





In addition to waypoints, the following items can be set for each route.

- (1) RADIUS: The arrival circle radius can be set.
- (2) WIDTH: The port and starboard route widths can be set.
- (3) PLAN SPEED: The planned speed can be set.
- (4) GC/RL: The distance calculation method can be set.
GC: Distance is calculated using the great circle method.
RL: Distance is calculated using the rhumb line method.
- (5) STATUS: You can set whether the waypoint will be use or not.
USE: The waypoint is used.
SKIP: The waypoint remains on the route, but is skipped.

Supplement

- Great-Circle Sailing (GC): The shortest distance from the current position to the waypoint can be used, but the bearing will be different from that determined on nautical chart, and will change during movement.
- Rhumb line Sailing (RL): Sailing can be performed directly from the current position to the waypoint, without changing bearing. The ship bearing will match that obtained by drawing a straight line on a nautical chart between the current position and the waypoint.
- Great-circle sailing is generally used for long distance sailing, and Rhumb line sailing is used for relatively short distance sailing.



Procedure



1. Press the  key to display the main menu.
2. Press the  key to select "WPT/ROUTE" and "MAKE ROUTE/LIST," and press the  key.
3. Move the cursor to the number you wish to register, and press the  key. The route information screen will be displayed.

1) Setting Waypoint radius, Route width, Plan speed and Distance calculation method

4. Select "RADIUS," "WIDTH," "PLAN SPEED," and "GC/RL," and then enter each.

2) Setting Waypoints

5. Press the  key to select "WPT LIST" and press the  key.





- The waypoint list of route will be displayed. Press the  key to select the top of blank area, and press the  key.

The following items can be set in WPT No.



WPT No: You can set the waypoint number.

WPT LIST: You can select waypoint number from waypoint list.

2-1) Entering Waypoint number by key

- Press the  key to select "WPT No", "WPT No" and "WPT No" and press the  key.
- Press the  key to enter the waypoint number, and press the  key.

2-2) Selecting Waypoint number from Waypoint list





- Press the  key to select "WPT No", "WPT LIST". The waypoint list will be displayed.
- Press the  key to move the cursor to the waypoint number you wish to select, and press the  key.

- Select "STATUS" of the waypoint.

The following items can be set in STATUS.

USE: The waypoint is used as a waypoint.

SKIP: Although the waypoint has been registered for the route, this waypoint is skipped to go to the next waypoint.

- Press the  key to select "ENTER," and press the  key.
- When the waypoint has been registered, the screen will return to the waypoint list. Similarly, select a waypoint.
- When you have completed selection, press the  key to return to route information screen.
- Press the  key to select "ENTER," and press the  key.
Total distance and TTG (required time) will be displayed.

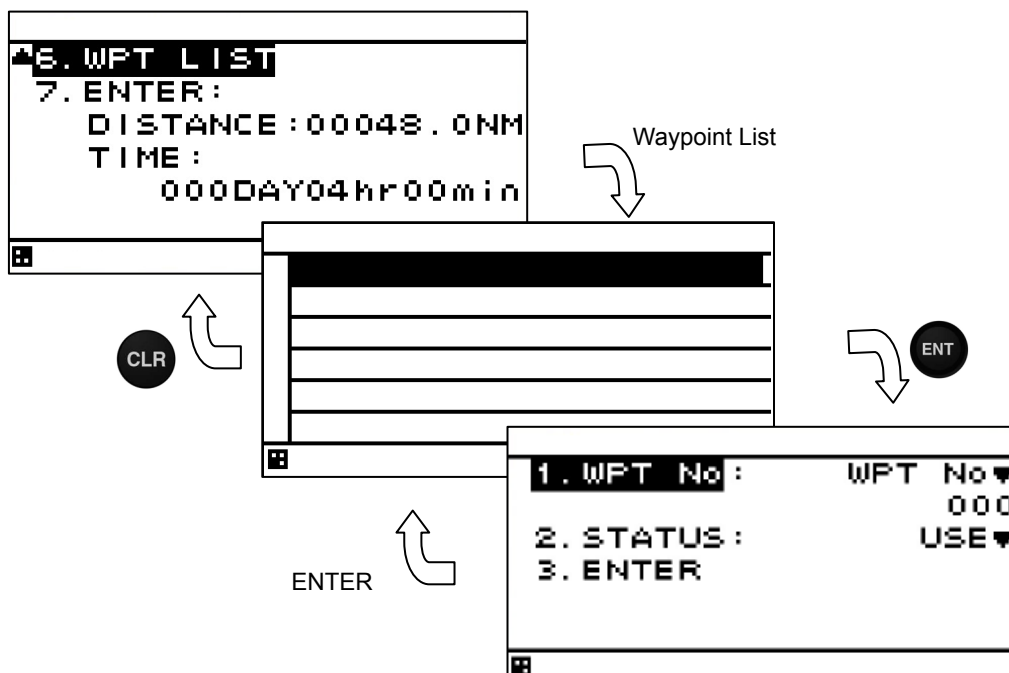

4.5.3 Editing Routes







- Route number and route information can be changed, and waypoints can be skipped, added, or deleted.

4.5.3.1 Changing Route Number

The same information is entered in the input route number. Information about the route number before change also remains.







Delete a route with reference to "4.5.5 Deleting Routes" to delete the information before change.

Procedure

1. Press the  key to display the main menu.
2. Press the  key to select "WPT/ROUTE" and "MAKE ROUTE/LIST," and press the  key.
3. Move the cursor to the route number you wish to edit, and press the  key. The route information screen will be displayed.
4. Press the  key to select "ROUTE No." and enter the route number.
5. Press the  key to select "ENTER," and press the  key.

4.5.3.2 Changing route Information

Procedure





1. Press the  key to display the main menu.
2. Press the  key to select "WPT/ROUTE" and "MAKE ROUTE/LIST," and press the  key.
3. Move the cursor to the route number you wish to edit, and press the  key. The route information screen will be displayed.
4. Press the  key to select "RADIUS," "WIDTH," "PLAN SPEED," and "GC/RL," and then enter each.
5. Press the  key to select "ENTER," and press the  key.







4.5.3.3 Skipping Route Waypoint

Waypoints on the routes can be skipped.



If skipped, a route connecting the previous and next waypoints will be created.

Procedure

1. Press the  key to display the main menu.
2. Press the  key to select "WPT/ROUTE" and "MAKE ROUTE/LIST," and press the  key.
3. Move the cursor to the route number you wish to edit, and press the  key. The route information screen will be displayed.

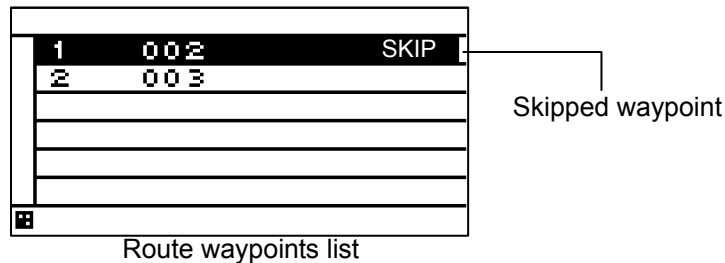
5. Press the  key to select "WPT LIST," and press the  key. Waypoint List will be displayed.
4. Move the cursor to the waypoint number you wish to skip, and press the  key.
6. Press the  key to select "STATUS", "SKIP" and press the  key.
To stop the SKIP, select "USE".
7. Press the  key to select "ENTER" and press the  key.



8. Press the  key to back the route information screen
9. Press the  key to select "ENTER" and press the  key.

4.5.3.4 Adding Route Waypoints

Waypoints can be added at any position along the created routes.

Procedure

1. Refer to "4.5.1 Displaying the Route List" select the route to which you wish to add a waypoint, and display the route waypoint list

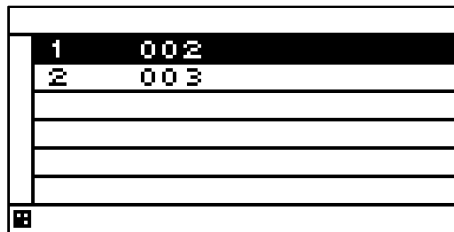

登録されている目的地リスト



2. Move the cursor to the waypoint number you wish to register, and press the  key.

Ex 1) To add a waypoint between 1 and 2, move the cursor to waypoint 2.

Ex 2) To add a waypoint before 1 move the cursor to waypoint 1

Ex 3) To add a waypoint after the final waypoint, move the cursor past the final waypoint.

To make an addition after the final waypoint, press 

To make an addition between waypoints, or before the first waypoint, press and hold  and  for 1 second.

The waypoint information screen will be displayed.

Ex 1) Adding a waypoint between 1 and 2

Move cursor to second waypoint

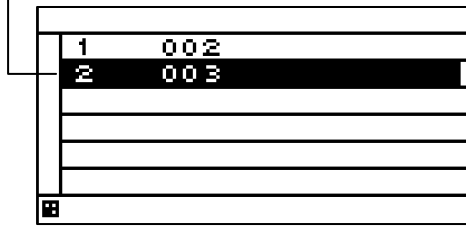

Waypoint List

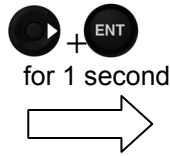

Waypoint Information screen

Ex 2) Adding a waypoint at the start.

Move cursor to first waypoint

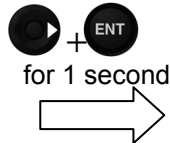
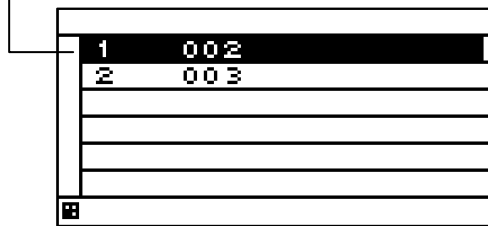

Ex 2) Adding a waypoint at the end.

Move cursor to after last waypoint

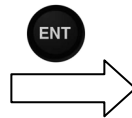
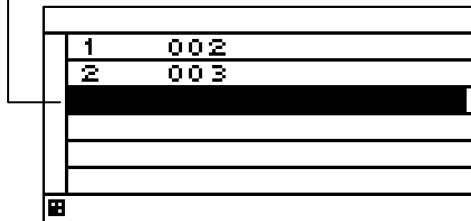







3. Press the key to select "WPT No" and enter the waypoint number.
4. Press the key to select "STATUS" and select "USE" or "SKIP".
5. Press the key to select "ENTER," and press the key.
6. When you have completed addition, press the key to return to route information screen.
7. Press the key to select "ENTER," and press the key.

4.5.3.5 Deleting Route Waypoints



The waypoints that have been registered on routes can be deleted.

Procedure

1. Press the key to display the main menu.
2. Press the key to select "WPT/ROUTE" and "MAKE ROUTE/LIST," and press the key.
3. Move the cursor to the number you wish to edit, and press the key. The route information screen will be displayed.

5. Press the  key to select "WPT LIST," and press the  key.
6. The waypoint list of route will be displayed. Press the  to select the waypoint you wish to delete, and press the  key.
7. Press the  key to select "DELETE" and press the  key.
8. When the following popup is displayed, press "YES".

DELETE OK?
YES NO

9. When you have completed deletion, press the  key to return to route information screen.
10. Press the  key to select "ENTER," and press the  key.



4.5.4 Copying Routes

- To copy a route to another route, use the number to which the route is to be copied as the route number in the route list. The source information is not deleted but is copied. Please refer to "4.5.3.1 Changing Route number" for details.

4.5.5 Deleting Routes

- Routes registered between 1 and 20 can be deleted.
- The waypoint on the route to be deleted can also be deleted at the same time.
- If the waypoint is also detected, the waypoint used on the different route is not deleted.
- Active routes cannot be deleted.



Procedure

1. Press the  key to display the main menu.
2. Press the  key to select "WPT/ROUTE" and "DELETE ROUTE," and press the  key.



An overview of the route deletion submenu is as follows.

- (1) ROUTE LIST: Specify the route to be deleted on the route list.
- (2) FROM TO: Enter the start and end points and specify the range to be deleted.
- (3) ALL DELETE: Delete all routes between 1 and 20.

3. Press the  key to select the route deletion method, and press the  key.

(1) When "ROUTE LIST" is selected



The route list will be displayed. Move the cursor to specify the route you wish to delete, and press the  key.

(2) When "FROM TO" is selected

Enter the start ("FROM") and end ("TO") points, select "DELETE ROUTE," and press the  key.

(3) When "ALL DELETE" is selected

All routes in the route list are deleted.

4. Press the  key to select whether the waypoint is to be deleted, and press the  key.

An overview of waypoint deletion submenu is as follows.

- (1) ROUTE + WPT: The route as well as the waypoint used on the route are deleted. However, the waypoint used on the different route is not deleted.
- (2) ROUTE: Only the route is deleted.





4.6 Performing Navigation

- Registered and temporary routes can be started.
- Routes can be selected by the following methods.
 - (1) Selecting a route from the route list
 - (2) Selecting a waypoint with the GOTO key
 - (3) Selecting a route with the GOTO key
 - (4) Creating a temporary route with the GOTO key
- The waypoint is updated when own ship arrives the waypoint arrival circle.

4.6.1 Selecting a Route from the Route List

Routes can be selected from the route list and started.

Procedure

1. Press the  key to display the main menu.
2. Press the  key to select "WPT/ROUTE" and "ROUTE START/END," and press the  key.
3. The route list will be displayed. Move the cursor to the route number you wish to start, and press the  key.

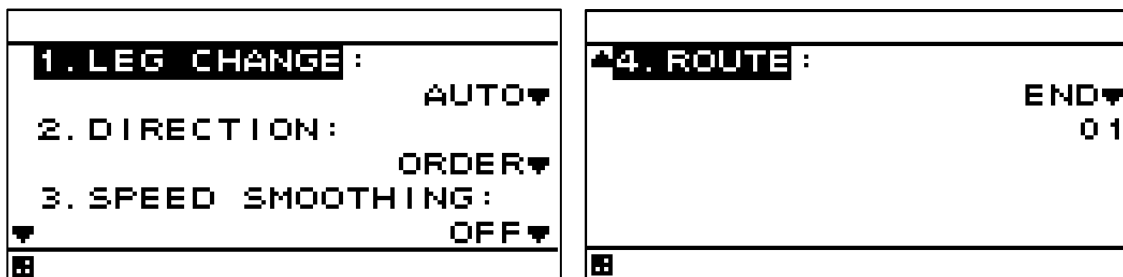

An overview of each submenu is as follows.

(1) LEG CHANGE

You can set whether a waypoint is updated automatically or manually when own ship arrives the waypoint arrival circle.

AUTO: The waypoint is automatically updated to the next waypoint.

MANUAL: The waypoint is updated manually to the next waypoint.

When the arrival circle is reached, the following message will display. Press the  key to update the waypoint.

UPDATE WPT
PLEASE PUSH ENT

(2) DIRECTION

You can set whether to perform navigation in the order of waypoints or starting from the final waypoint.

ORDER: Navigation is performed in order the order of waypoints.

REVERSE: Navigation is performed starting from the final waypoint.

(3) SPEED SMOOTHING

When waypoint arrival time is calculated, ship speed is smoothed.

If the smoothing value is greater, the calculation result is stable but the difference becomes larger.

In the sensor that calculates the ship speed, the ship speed may have already been

smoothed.

It is recommended to set this value only if the calculation result varies largely.

(4) ROUTE

You can set whether to start or stop navigation.

START: Navigation is started.

END: Navigation is stopped.

(1) To set waypoint update method

Select "LEG CHANGE", select the waypoint update method, and press the  key.

(2) To set direction

Select "DIRECTION", select the direction, and press the  key.

(3) To set smoothing of ship speed

Select "SPEED SMOOTHING," "ON", enter the value, and press the  key.

4. Select "ROUTE", select "START," and press the  key.

To stop the navigation, select "END" and press the  key.

4.6.2 Selecting a Waypoint/Route with the GOTO Key

- If a waypoint or route is selected with the GOTO key, navigation starts to that waypoint.
- Routes created with GOTO key are stored as temporary route with route number 21
- The waypoint can be selected by the following methods.
 - (1) Set HOME PORT as the waypoint.
 - (2) Enter the waypoint number.
 - (3) Enter the route number.
 - (4) Set the cursor position as the waypoint
 - (5) Select from each list (waypoint list and route list).

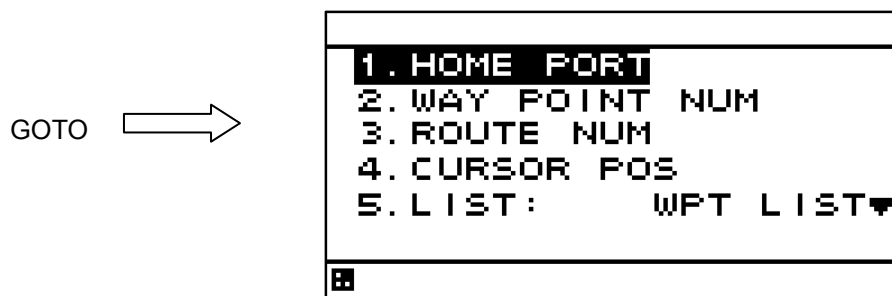







Procedure

(1) Set HOME PORT as the waypoint

HOME sets the HOME PORT registered at the waypoint number 001 as the waypoint.

If a waypoint is registered as HOME, it can be easily set as a waypoint.









If HOME PORT is not registered, "HOME PORT" will not be displayed.

1. Press the  key.
2. Press the  key to select "HOME PORT," and press the  key.
3. Press the  key to select "RADIUS", "WIDTH" and "GC/RL", and press the  key.
Please refer to "4.5.2 Creating Routes" for details.
4. Press the  key to select "START," and press the  key.

Navigation will start with the HOME PORT as the waypoint.









(2) Enter the waypoint number

If the waypoint number is known, enter the number and set the waypoint.

1. Press the  key.
2. Press the  key to select "WAY POINT NUM," and press the  key.
3. Press the  key to enter the waypoint number, and press the  key.
4. Press the  key to set "RADIUS", "WIDTH" and "GC/RL", and press the  key.
Please refer to "4.5.2 Creating Routes" for details.
5. Press the  key to select "START," and press the  key.
Navigation will be started.







(3) Select a route number

If the route number is known, enter the number and set the route.

1. Press the  key.
2. Press the  key to select "ROUTE NUM," and press the  key.
3. Press the  key to enter the route number, and press the  key. Navigation will be started.
4. Press the  key to set "LEG CHANGE", "DIRECTION" and "SPEED SMOOTHING", and press the  key.
Please refer to "4.6.1 Selecting a Route from the Route List" for details.
5. Press the  key to select "ROUTE" and "START", and press the  key.
Navigation will be started.

(4) Set the cursor position as the waypoint

Any cursor position on the plot screen can be set as waypoints. Multiple waypoints can be selected and a temporary route created. Temporary routes can also be added to the route list.

1. Press the  key.
2. Press the  key to select "CURSOR POS," and press the  key.
3. The plot screen will be displayed. Press the  key to display the cursor.
Move the cursor to the waypoint position, and press the  key.
For multiple waypoints, move the cursor again, and press the  key.
Pressing the  key deletes the previous waypoint.

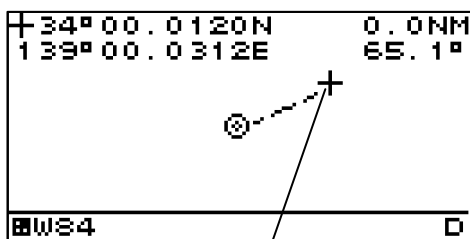



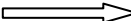

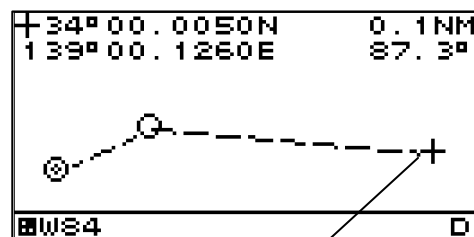
At point you wish to make
waypoint, press 

Move cursor



At point you wish to make final
waypoint, press  twice.

4. Press the  key again at the final waypoint to decide the temporary route
5. Press the  key to set "RADIUS", "WIDTH" and "GC/RL", and press the  key.
Please refer to "4.5.2 Creating Route" for details.
6. Press the  key to select "START", and press the  key.

The following popup is displayed. If you wish to register the route in the route list, select "YES". The set route is registered in the smaller number of empty route number, and navigation is performed.

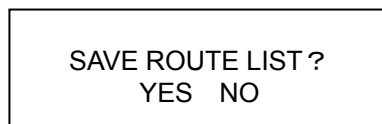









If you don't wish to register the route in the route list, select "NO". However, the set route is registered in the route number 21 as the temporary route. The temporary route (route number 21) can't be edited.

The waypoints selected with the cursor will also be registered in the waypoint list.

(5) Select from the waypoint list









A waypoint can be selected from the waypoint list.

1. Press the  key.
2. Press the  key to select "LIST" and "WPT LIST", and press the  key.
3. Press the  key to set the waypoint number you wish to set as the waypoint.
4. Press the  key to set "RADIUS", "WIDTH" and "GC/RL", and press the  key.
Please refer to "4.5.2 Creating Route" for details.
5. Press the  key to select "START", and press the  key.

Navigation will be started.

(6) Select a route from the route list

The GOTO key can be used to select and execute a route.

1. Press the  key.
2. Press the  key to select "LIST" and "ROUTE LIST", and press the  key.
3. Press the  key to select route, and press the  key.
4. Press the  key to set "LEG CHANGE", "DIRECTION" and "SPEED SMOOTHING", and press the  key.
Please refer to "4.6 Performing Navigation" for details.
5. Press the  key to select "ROUTE" and "START", and press the  key.

Navigation will be started.

4.6.3 Stopping Navigation

- Navigation currently underway can be stopped.
- To end navigation, use two methods: selecting in the menu and holding down the  key.

4.6.3.1 Ending Navigation with GOTO Key





Procedure

1. Press and hold down the  key (3 seconds or more).
2. When the following popup is displayed, press "YES".





4.6.3.2 Ending Navigation in Menu

Procedure

1. Press the  key to display the menu.
2. Press the  key to select "WPT/ROUTE," "ROUTE START/END," and "ROUTE," and press the  key.
3. Press the  key to select "ROUTE," and set "END." Navigation will be stopped.



4.7 Entering Comments

- Comments of up to 8 characters can be added to waypoints.
- Use the  and  keys to select from character list and enter characters.



4.7.1 Text Entry

The entry example will show how to input "ABC" on the waypoint comment entry screen.



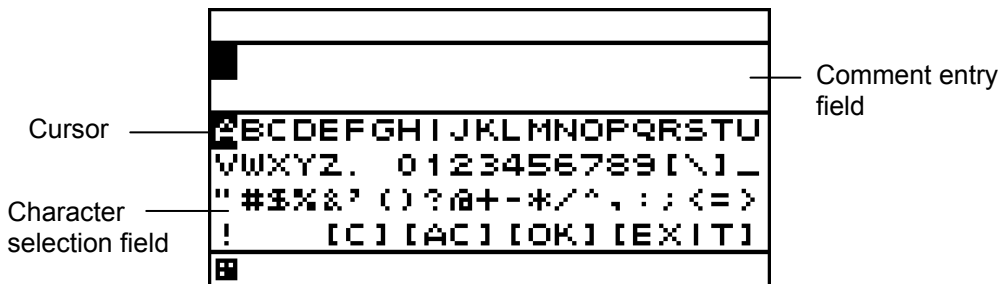

Procedure

1. "COMMENT" is selected with reference to "4.4.3 Editing Waypoint Information."
2. Enter the character entry mode.

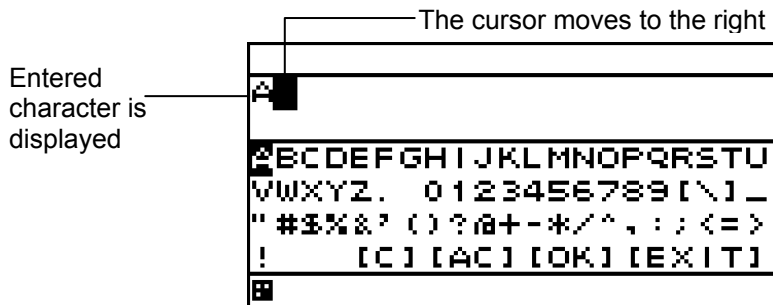

3. To enter "A" in "ABC," press the  key to move the cursor to "A."
4. When the cursor is set to "A," press the  key to enter.
5. "A" will be displayed in the comment entry field. The cursor in the comment entry field shifts one to the right to enter the mode in which the next character can be entered.



6. Similarly, press the  key to move the cursor to "B" and "C," set the cursor to "B" and "C," and press the  key to enter.
7. When entry has been completed, press the  key to select "OK," and press the  key. The entered character is reflected.

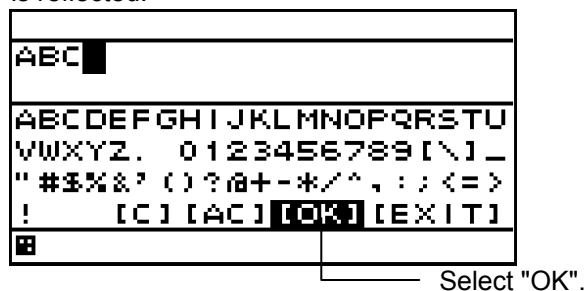

4.7.2 Deleting Text

The entered characters can be deleted.



4.7.2.1 Deleting One Character

- One character in a comment is deleted.
- One character before the cursor is deleted. If the cursor is located at the start, the first character is deleted.

Procedure

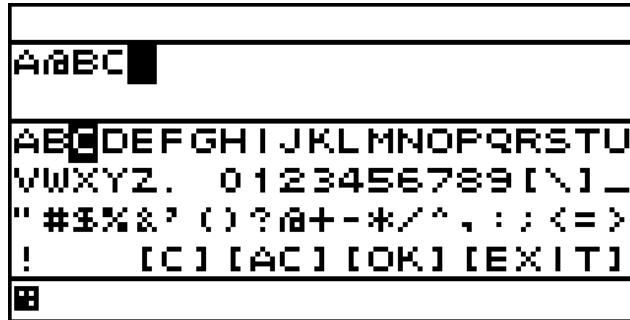
- As an operation example, the procedure for deleting "@" below is explained.



1. When the cursor in the character selection field is located at the top, press the  key to move the cursor to the comment entry field.
2. Set the cursor to after the character you wish to delete, press the  key to return to the character selection field, and select [C] or press the  key.

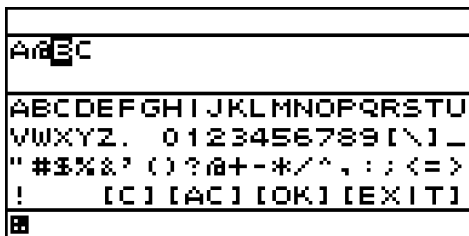

Move the cursor after the character to be deleted

Select [C] or
press 
key

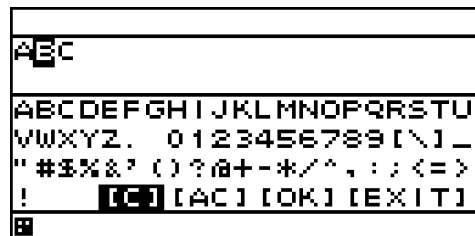



"@" is deleted

4.7.2.2 Deleting All Characters

- All characters in the comment entry field are deleted.

Procedure

1. Press the  key to select [AC], and press the  key. All entered characters will be deleted.

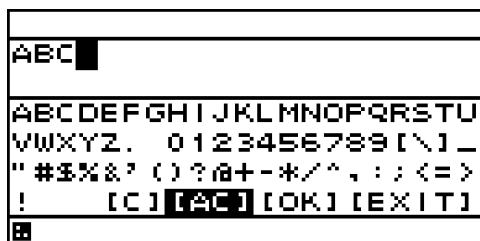

Move the cursor to the [AC] position

Select [AC]

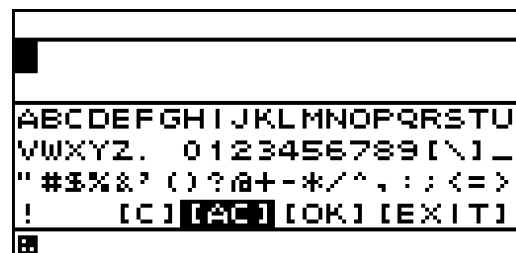



All characters are deleted

4.7.3 Adding Text

- Characters can be added to comments.

Procedure

1. When the cursor in the character selection field is located at the top, press the  key to move the cursor to the comment entry field.
2. Press the  key to move the cursor to the position where you wish to add a character.
3. Press the  key to move the cursor to the character selection field.
4. Refer to "4.7.1 Text Entry," and enter characters.

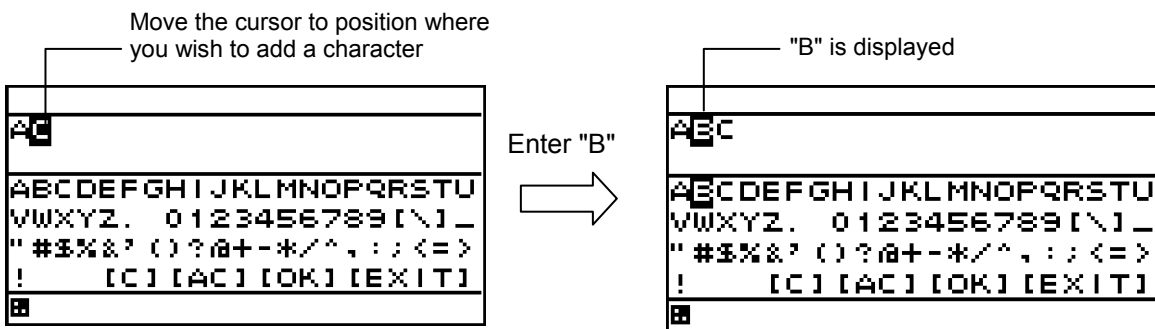

To add "B"





4.7.4 Canceling Comment Entry

- Comment entry is ended without deciding characters.

Procedure

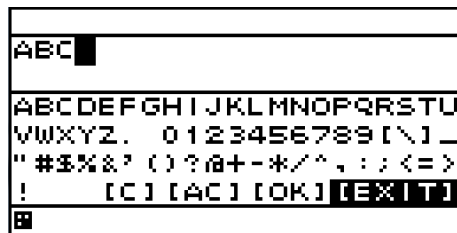
1. Press the  key to select [EXIT] in the character selection field, and press the  key.



2. When the following pop-up is displayed, to end without saving characters, press the  key to select "YES," and press the  key.

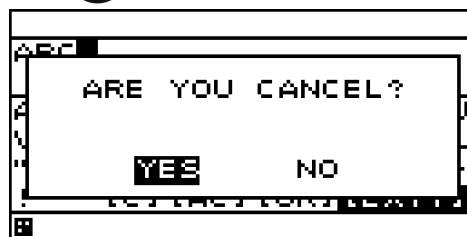

4.8 MOB

- The MOB (Man Overboard) function is used to save the position at which a person or object has fallen overboard. This function allows rapid return to that position.
 - The MOB function is valid on all screens.
- If MOB is performed, a MOB mark will be displayed on a Man Overboard position and the route which made the Man Overboard position the destination will be performed. The bearing and distance to the Man Overboard position from a current position are displayed on BRG and DTG.

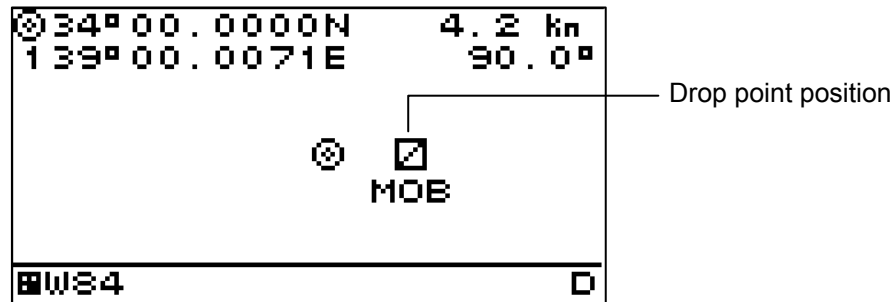

Procedure

1. Press and hold down the  key for 3 seconds or more.

The following pop-up will be displayed, and the MOB function performed.

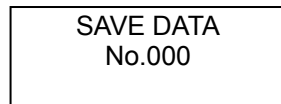

To stop the MOB function, press and hold down the  key for 3 seconds or more.

Supplement

MOB is registered as waypoint number 000 in the waypoint list.

4.9 Setting Display

When “Display” is selected on the main menu, a display menu is displayed.

On the display menu, LCD (contrast and back light), click sound, screen selection, and back light color can be set.







Each submenu is outlined below.

- 1) LCD: Adjusts the contrast and sets the back light level.
- 2) CLICK SOUND: Turns on/off the click sound.
- 3) DISPLAY SELECTION: Selects a screen.
- 4) BACK LIGHT: Selects a back light color (white/orange).

4.9.1 Adjusting contrast

- Adjust the LCD contrast.
- The darkest contrast is 1 and the lightest contrast is 13.
- The default setting is 7.





Procedure

1. Display a main menu by pressing .
2. Select “DISPLAY”, “LCD”, and “CONTRAST” in this order by using .
3. Enter a contrast value by using  and press .

4.9.2 Adjusting back light

- Brightness can be changed by using . Four levels of brightness are available, bright, medium, dark, and off.
This section shows how to set a level value of each brightness.

Procedure

1. Display a main menu by pressing .
2. Select “DISPLAY”, “LCD”, and “DIMMER MAXIMUM/TYPICAL/MINIMUM” in this order by using .
3. Select a brightness value by using  and press .





Supplement

Enter the highest value in “MAXIMUM” and the lowest value in “MINIMUM”.

4.9.3 Setting a click sound

- Turn on/off a key-operation click sound.
ON: Enables a click sound. When the key is pressed, a click sound is emitted.
OFF: Disables a click sound.

Procedure

1. Display a main menu by pressing .
2. Select "DISPLAY" and "CLICK SOUND" in that order by using .
3. Select "ON" or "OFF" by using  and press .

4.9.4 Setting a display screen

Up to six display screens can be registered in this display unit.

The display screen can be switched either manually by using  or automatically (auto screen function).

The auto screen function enables the setting of a switching interval. Switching can also be notified by emitting a buzzer sound.

Only the integer section or the decimal section of a indication character can be expanded and displayed. (Display mode)

The setting of the auto screen function and the display mode are performed by "STEP3."

The screen structures of each display screen include customized screens that can be set freely, special screens that do not allow any setting, and graphic screens. The contents to be displayed on the display screen can be selected.

The screen selection procedure is as follows.



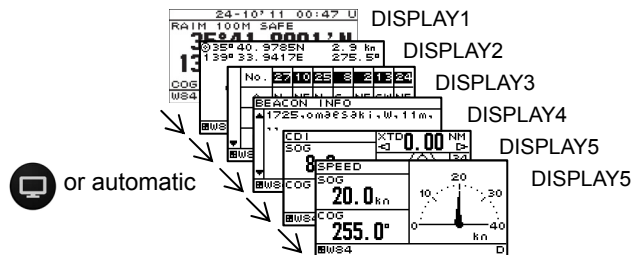

- STEP1 Select a display screen.
- STEP2 Select a screen structure.
- STEP3 Select the display contents.

4.9.4.1 STEP1 Selecting a screen

Up to six display screens can be registered in this display unit.



Procedure

1. Display a main menu by pressing  (normal mode).
2. Select "DISPLAY" and "DISPLAY SELECTION" in that order by using  and press .
3. Select a display screen from "DISPLAY1" to "DISPLAY6" by using  and press .

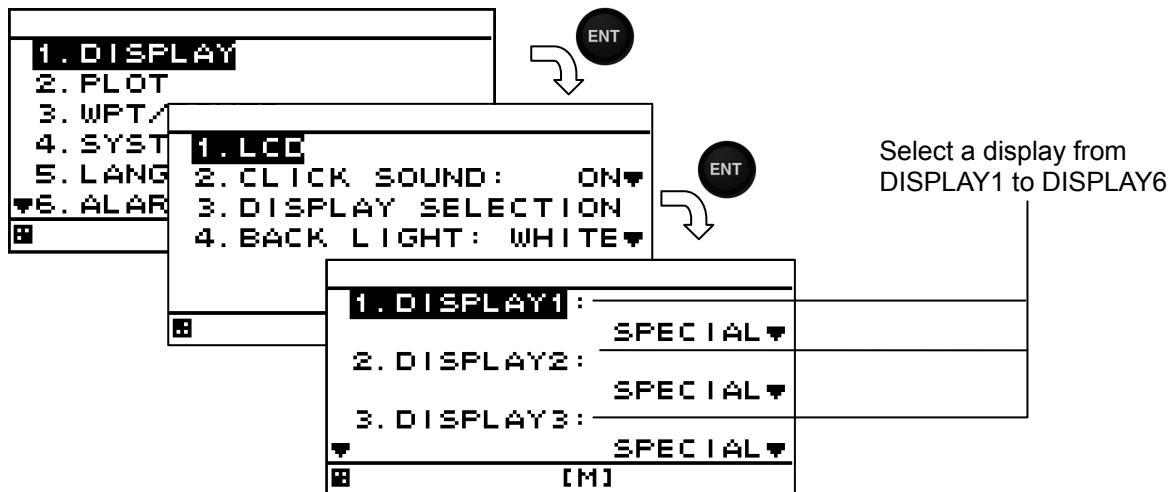

4.9.4.2 STEP2 Selecting a screen structure

The screen structures of each display screen include customized screens that can be set freely, special screens that do not allow any setting, and graphic screens.

Select a screen structure.

When display structure selection is set to "OFF", the display screen cannot be registered.

Customized screen

One screen can be segmented into screens 1 to 4. Up to four contents can be displayed concurrently.

Special screen and graphic screen



Users cannot change the screen structure. Special contents for the model are displayed on the screen.

The following screen structures can be selected.

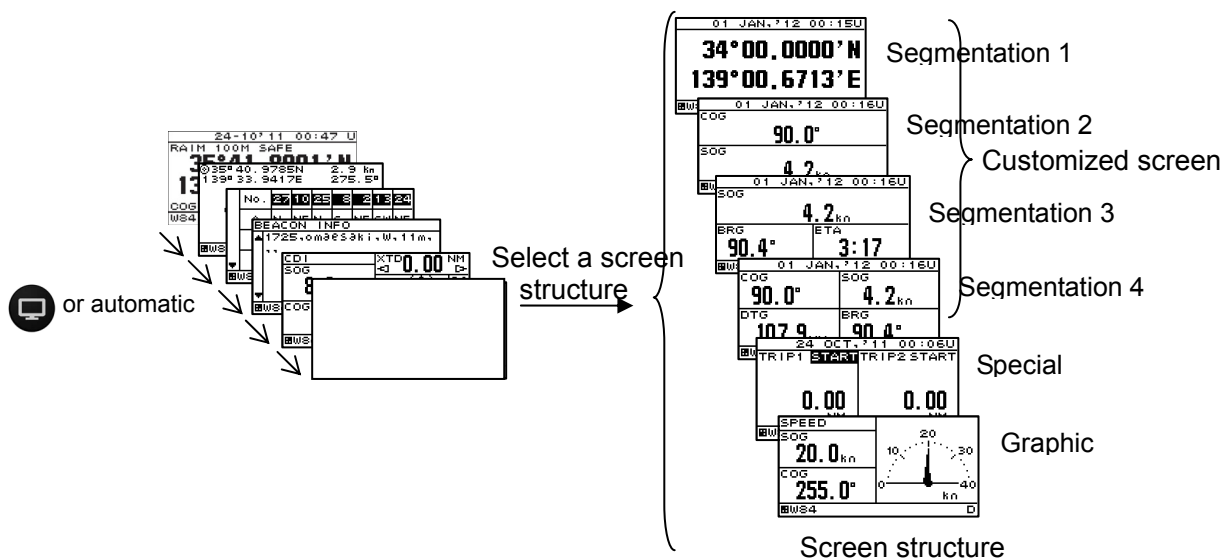
- 1) SEGMENTATION1: Full screen
- 2) SEGMENTATION2: The screen is segmented into two sections.
- 3) SEGMENTATION3: The screen is segmented into three sections.
- 4) SEGMENTATION4: The screen is segmented into four sections.
- 5) SPECIAL: Special GPS screen
- 6) GRAPICH: Graphic screen
- 7) OFF: The screen can not be registered.



Procedure

1. Select a display screen by referencing "STEP1".
2. Select a screen structure from "SEGMENTATION1", "SEGMENTATION2", "SEGMENTATION3", "SEGMENTATION4", "SPECIAL", "GRAPHIC" and "OFF" by using  and press .

1. DISPLAY1:	SPECIAL ▾
2. DISPLAY2:	SPECIAL ▾
3. DISPLAY3:	SPECIAL ▾
▾	[M]

Select
SEGMENTATION1,
SEGMENTATION2,
SEGMENTATION3,
SEGMENTATION4,
SPECIAL, or
GRAPHIC.
OFF

4.9.4.3 STEP3 Selecting display contents

Select as many display contents as the number of screens that are created by segmentation. For instance, for a 2-segmentation screen, select the display content for one half of the screen and then select the display content for the other half of the screen (see the diagram below).

The display content of a customized screen is divided according to the category. Initially, select a category and a display item. Table 4-1 shows the categories and display contents.

A special screen and a graphic screen are not classified according to the category.

Only the integer section or a decimal section of some item that is selected on a 1-segmentation customized screen or a special screen can be expanded (Display mode).

If display content selection is set to "OFF", no information is displayed in the area.

Set the auto screen function and display mode (only segmentation 1 screen) in STEP3. The following functions can be set.

1-1) AUTO SCREEN: ON – Enables the auto screen function.

OFF – Disables the auto screen function.

1-2) SOUND : SOUND1 – The buzzer of "Pippi" sound is sounded at the time of a screen change.

SOUND2 – The buzzer of "Pip" sound is sounded at the time of a screen change.

OFF – Does not emit a buzzer sound even if the screen is switched.

1-3) TIME: Sets a screen switching time. A time of up to 10 seconds can be set.

2-1) DISPLAY MODE : normal It displays in the character of the same size.

special 1 Only integer part is expanded and displayed.

special 2 Only a decimal part is expanded and displayed.

auto range Integer part or a decimal part is expanded and it displays the optimal.

Example) Procedure for selecting display contents for a 2-segmentation screen

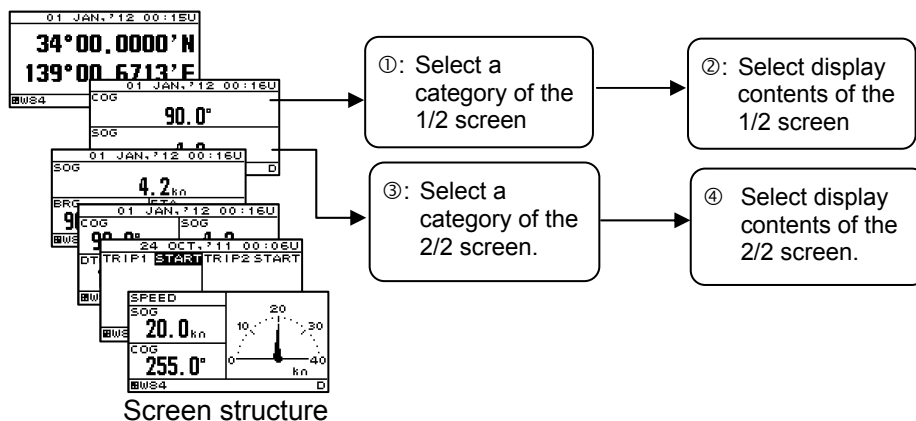



Selecting display contents for 2-segmentation screen

Procedure

1. Select a screen structure by referencing "STEP1" and "STEP2".

Customized screen

2. Select a screen section to be displayed by using  and press .

Select the screen section from the following:





segmentation1 screen: "DISPLAY"

segmentation2 screen: "DISPLAY 1/2" "DISPLAY 2/2"

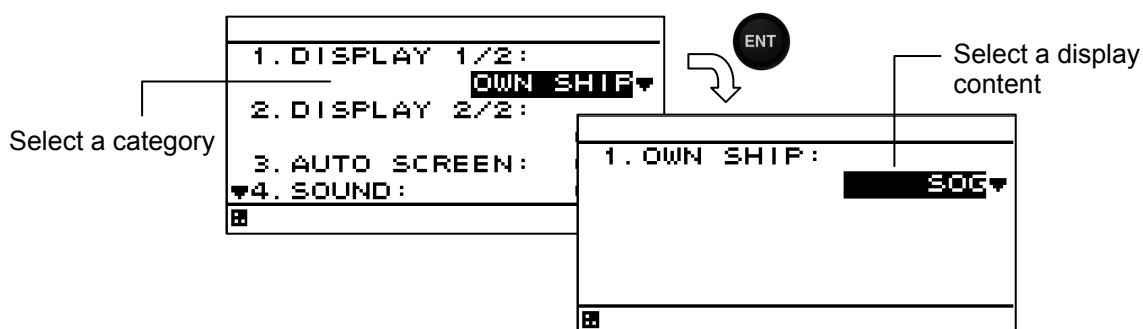



segmentation3 screen: "DISPLAY 1/3" "DISPLAY 2/3" "DISPLAY 3/3"

segmentation4 screen: "DISPLAY 1/4" "DISPLAY 2/4" "DISPLAY 3/4" "DISPLAY 4/4"



3. Select a category by using  and press .
4. Select display contents by using  and press .
5. Go to procedure 6 when setting an auto screen.

Fixed screen and graphic screen

2. Select "1. DISPLAY" by using  and press .
3. Select display contents by using  and press .
4. Go to procedure 6 when setting an auto screen.

Table







Category	Display contents
OWN SHIP	LAT/LON※1,COG,SOG
NAVIGATION INFO	XTD,BRG,TTG,DTG,ETA,VTD,VEAR,CMG
Special screen	BEACON INFO, NAVIGATION INFO, DISTANCE, WAYPOINT INFO
Graphic screen	GPS, PLOT, CDI, SPEED1, SPEED2

※1:Only segmation1 screen

Setting an auto screen

On an auto screen, set a screen switching time and whether a buzzer sound is emitted at screen switching.





- Select "ON" or "OFF" under "AUTO SCREEN" by using  and press .
- Select "SOUND1", "SOUND2" and "OFF" under "SOUND" by using  and press .
- Select "TIME" by using .
- Enter a switching time by using  and press .

Starting an auto screen

- Press and hold  for 1 second or more.

Stopping an auto screen

- Press any keys except  and .





Setting a display mode

The display mode can be set only with segmentaion1 screen.

The contents of a display with an effective auto range are SOG, VTD, VEAR, DTG, XTD and TTG. Even if it sets up an auto range by the other contents of a display, it becomes the normal display. An auto range changes a display in the following range.

Auto range

The contents of a display	Integer part expanded display	Usual display	Decimal part expanded display
SOG/VTD/VEAR	10kn or more	1.0 - 9.9kn	0.9kn or less
DTG/XTD	10NM or more	1.00 - 9.99NM	0.99NM or less
TTG	2 hours or more	60min - 1hr59min	59min or less

- The contents of a display are set up with the above-mentioned operating procedure.
- Select the "DISPLAY MODE" by using  and press .
- Select the "NORMAL", "SPECIAL1", "SPECIAL2" or "AUTO RANGE" by using  and press .

Example) SOG display

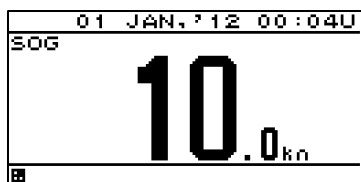

Integer part expanded display

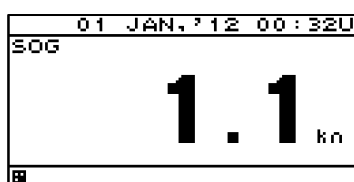

Normal display

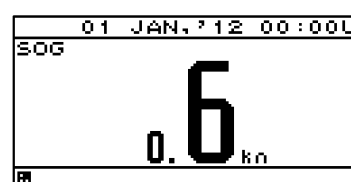



Decimal part expanded display

4.9.5 Selecting a back light color

Select white or orange as the back light color of the screen that is normally used.

Procedure

- Display a main menu by pressing .
- Select "DISPLAY" and "BACK LIGHT" in this order by using .
- Select "WHITE" or "ORANGE" by using  and press .

4.10 System Settings

- Select "SYSTEM" on the main menu to display the system setting screen.
- To change the system settings, place the unit in maintenance mode.

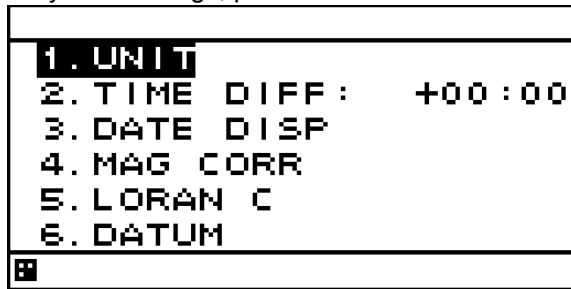



An overview of each submenu is as follows.

- (1) UNIT: The unit of speed and height is set.
- (2) TIME DIFF: Set the time difference between UTC and local time.
- (3) DATE DISP: Select the date format.
- (4) MAG CORR: Automatic or manual magnetic correction or turn magnetic correction off can be selected.
- (5) LORAN C: Convert latitude and longitude to LORAN C
- (6) DATUM: A geodetic system can be selected from the list in "Appendix 1 Geodetic System."

4.10.1 Setting Speed and Antenna height Unit

You can select "NM," "kn," "km," "km/h," "mi," "mi/h," "m," and "m/s" for speed and "m," "ft" and "fm" for antenna height unit.



Procedure

1. Refer to "4.15.1 Change to a maintenance mode" and display the maintenance menu.
2. Press the  key to select "SYSTEM", "UNIT" and "DIST/SPD" or "ANT HEIGHT" in order.
3. Press the  key to select the unit, and press the  key.

4.10.2 Setting the Time Difference

- You can set the time difference between your current location and UTC.
- For Japan, the time difference is +9 hours, so you would enter +09:00.
- When a time difference is set, "L" is displayed on the upper right of the screen.



Procedure

1. Refer to "4.15.1 Change to a maintenance mode" and display the maintenance menu.
2. Press the  key to select "SYSTEM" and "TIME DIFF" in order.
3. Press the  key to enter the time difference, and press the  key.

4.10.3 Setting the Date Display

- You can set the date display format to "DD MMM,'YY," "MMM DD,'YY," or "YY-MMM-DD."
YY: Year MMM: Month DD: Day

Procedure

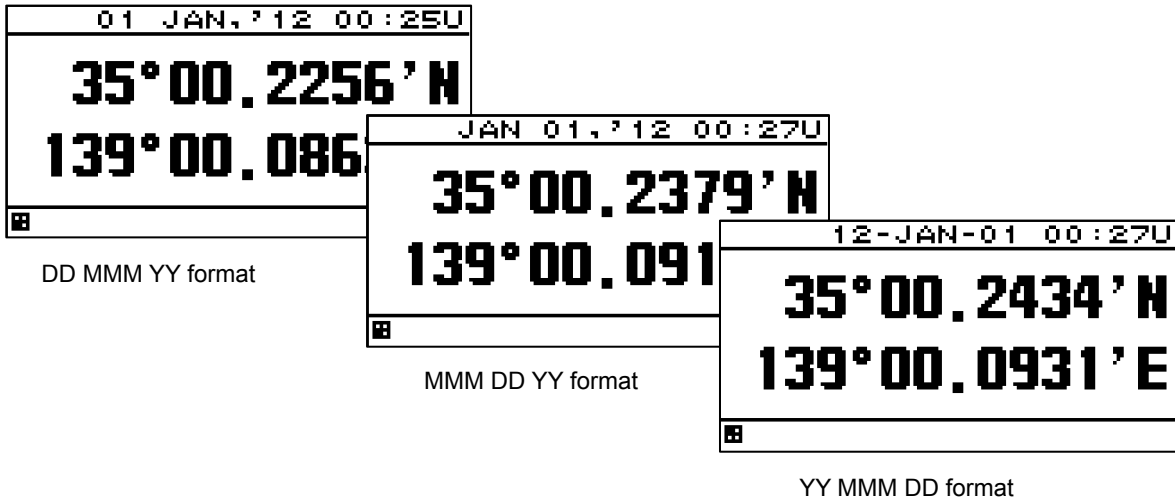

- Refer to "4.15.1 Change to a maintenance mode" and display the maintenance menu.
- Press the  key to select "SYSTEM" and "DATE DISP" in order.
- Press the  key to select the display format, and press the  key.





4.10.4 Setting Magnetic Correction

- You can set the method of magnetic correction to be automatic or manual, or turn magnetic correction off.
- If you select automatic, correction is automatically calculated for the correction value from the GPS position.
- If you select manual, correction is performed using a manually entered value.
- If you turn magnetic correction off, no correction is performed.
- Magnetic compensation can be applied only to a display or an output (usually, carry out the same setup for a display and an output).

Procedure

- Refer to "4.15.1 Change to a maintenance mode" and display the maintenance menu.
- Press the  key to select "SYSTEM" and "MAG CORR" in order.
- Select "DISPLAY" or "OUTPUT."
DISPLAY: The value which carried out magnetic compensation is displayed.
OUTPUT: The value which carried out magnetic compensation is outputted.
- Press the  key to select correction method, and press the  key.

When Manual is selected

- Press the  key to enter E/W and correction value, and press the  key.



Supplement

When connect to MID (NWZ-4610), carry out the same setup for a display and an output.

4.10.5 Displaying as Loran C time difference

Own ship position (latitude and longitude) can be displayed as LORAN C time difference.

Procedure

1. Refer to "4.15.1 Change to a maintenance mode" and display the maintenance menu.
2. Press the  key to select "SYSTEM," "LORAC C," "LORAN C" in order.
3. Press the  key to select "ON."
4. Set the GRI, TD1, TD2, TD1 CORR and TD2 CORR.

Supplement

- Configurable Loran c chains



4990 5930 5970 5980 5990 6730 6731 6780 7001 7030 7170 7270 7430 7499 7930 7950
7960 7970 7980 7990 8000 8290 8390 8830 8930 8970 8990 9007 9610 9930 9940 9960
9970 9980 9990

The waypoint position can not be displayed as LORAN C time difference.

4.10.6 Setting the Geodetic System

- You can select the geodetic system.
- You can select between 47 types of geodetic systems. For details, refer to "Appendix 1 Geodetic Systems."



Procedure

1. Refer to "4.15.1 Change to a maintenance mode" and display the maintenance menu.
2. Press the  key to select "SYSTEM" and "DATUM" in order.
3. Press the  key to select the geodetic system, and press the  key.

4.11 Language Settings

- You can set the display language to nine languages (English/Japanese (katakana)/German/French/Italian/Norwegian/Spanish/Vietnamese/Indonesian).
- To change the language, place the unit in the maintenance mode.

Procedure

1. Refer to "4.15.1 Change to a maintenance mode" and display the maintenance menu.
2. Press the  key to select "LANG." and "LANG" in order.
3. Press the  key to select the language, and press the  key.

4.12 Alert Settings

7 types of alerts can be configured.

When the set alert occurs, the pop-up and the alert icon "AL" on the status bar alert the occurrence of an alert. The screen lighting color can also be changed.

Pressing the  key stops pop-up, buzzer sound, and screen lighting, but the icon continues appearing until the alert has been resolved.

The unit must be placed in maintenance mode to change the alert settings.

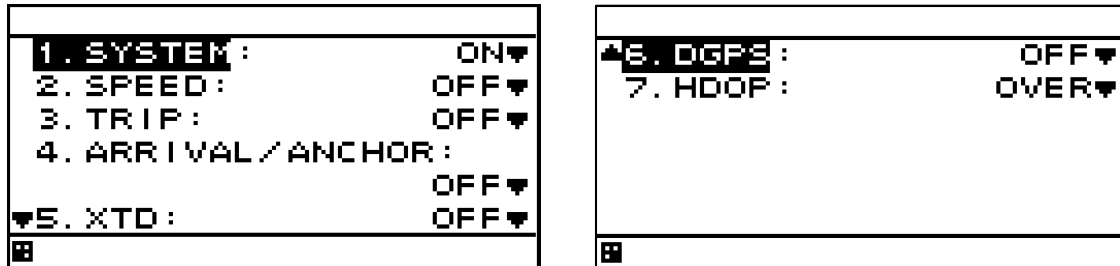

An overview of alert that can be set is as follows.

- (1) SYSTEM: An alert occurs when system failure occurs (for example: positioning is stopped).
- (2) SPEED: An alert occurs when the speed reaches the set range.
- (3) TRIP: An alert occurs when the trip exceeds the set value.
- (4) ARRIVAL/ANCHOR: An alert occurs when own ship reaches or leaves the arrival circle radius. Alerts cannot be set for both reaching and leaving.
- (5) XTD: An alert occurs when own ship exits the route width.
- (6) DGPS: An alert occurs when switching is done from GPS positioning to DGPS positioning or vice versa.
- (7) HDOP: An alert occurs when the GPS positioning HDOP value exceeds the set value.

The buzzer sound and screen brightness color when an alert occurs can be set.



- 1) SOUND ON: The buzzer sounds when an alert occurs.
OFF: The buzzer does not sound when an alert occurs.
- 2) LCD COLOR ON: The screen brightness color changes when an alert occurs.
OFF: The screen brightness color does not change when an alert occurs.

If normal brightness color is set to white, it becomes orange, and vice versa.

4.12.1 Setting a system alert

When GPS positioning is disabled or a system failure occurs, an alert is issued.

Procedure





1. Refer to "4.15.1 Change to a maintenance mode" and display the maintenance menu.
2. Select "ALARM" and "SYSTEM" in this order by using .
3. Select "ON" or "OFF" by using  and press .
4. Set an alert sound and screen back light by referencing "4.12.8 Setting a buzzer sound and screen back light".

4.12.2 Setting a vessel speed alert

When the vessel speed reaches the set range, the alert is issued.
The range can be selected from OVER, UNDER, IN RANGE, and OUTRANGE.

- OVER: An alert is issued when the vessel speed reaches or exceeds the set speed.
UNDER: An alert is issued when the vessel speed is equal to or slower than the set speed.
IN RANGE: An alert is issued when the vessel speed is between the lower limit value and the upper limit value.
OUT RANGE: An alert is issued when the vessel speed is equal to or slower than the lower limit value or equal to or higher than the upper limit value.
For IN RANGE and OUT RANGE, set the upper limit value and lower limit value.





Procedure

1. Refer to "4.15.1 Change to a maintenance mode" and display the maintenance menu.
2. Select "ALARM" and "SPEED" in this order by using .
3. Select "OVER", "UNDER", "IN RANGE", or "OUT RANGE" by using .
4. Select "OVER", "UNDER", "MAXIMUM" or "MINIMUM" by using .
5. Enter a vessel speed by using  and press .
6. Set an buzzer sound and screen back light by referencing "4.12.8 Setting a buzzer sound and screen back light".

4.12.3 Setting a TRIP alert

An alert is issued when the TRIP distance exceeds the set TRIP distance.



Procedure

1. Refer to "4.15.1 Change to a maintenance mode" and display the maintenance menu.
2. Select "ALARM" and "TRIP" in this order by using .
3. Select "OVER" by using .
4. Select "OVER" by using .
5. Enter a TRIP distance by using  and press .
6. Set an buzzer sound and screen back light by referencing "4.12.8 Setting a buzzer sound and screen back light".

4.12.4 Setting ARRIVAL/ANCHOR Alert

An alert occurs when own ship reaches or leaves the arrival circle set on the route.
Alerts cannot be set for both reaching and leaving.

Procedure

1. Refer to "4.15.1 Change to a maintenance mode" and display the maintenance menu.
2. Press the  key to select "ALARM" and "ARRIVAL/ANCHOR" in order.
3. Press the  key to select "OFF," "ARRIVAL," or "ANCHOR," and press the  key.
4. Set an buzzer sound and screen back light by referencing "4.12.8 Setting a buzzer sound and screen back light".

When the arrival or anchor alert occurs, the alert icon is displayed.

Arrival

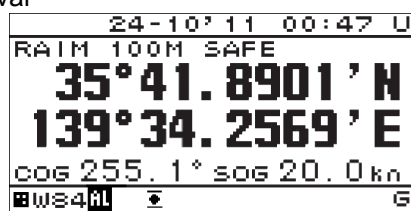

Arrival icon

Anchor

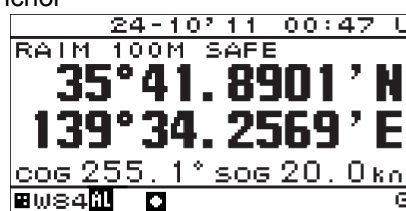



Anchor icon

4.12.5 Setting XTD Alert

An alert occurs when own ship exits the route.

Procedure

1. Refer to "4.15.1 Change to a maintenance mode" and display the maintenance menu.
2. Press the  key to select "ALARM" and "XTD" in order.
3. Press the  key to select "XTD" or "OFF," and press the  key.
4. Set an buzzer sound and screen back light by referencing "4.12.8 Setting a buzzer sound and screen back light".

When the XTD alert occurs, the alert icon is displayed.

XTD

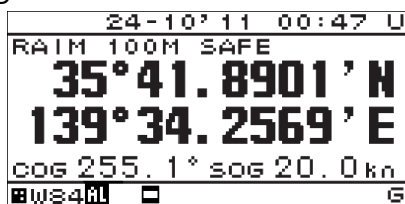

XTD icon



4.12.6 Setting DGPS Alert

An alert occurs when switching is done from GPS positioning to DGPS positioning or vice versa.

Even if generated by DGPS alert, "  icon and pop-up are not indicated.

It is reported that the audible tone changed the positioning state in one time of "Pi" and. Moreover, screen lighting is unchangeable at the time of alert generating.

Procedure

1. Refer to "4.15.1 Change to a maintenance mode" and display the maintenance menu.
2. Press the  key to select "ALARM" and "DGPS" in order.
3. Press the  key to select "ON→OFF", "OFF→ON", "OFF↔ON", "OFF" and press the  key.
4. Set an buzzer sound and screen back light by referencing "4.12.8 Setting a buzzer sound and screen back light".

ON → OFF: An alert will occur when DGPS positioning switches to GPS positioning.





OFF → ON: An alert will occur when GPS positioning switches to DGPS positioning.

OFF↔ON: An alert will occur when DGPS positioning switches to GPS positioning or vice versa.

4.12.7 Setting HDOP Alert

An alert occurs when the GPS positioning HDOP value exceeds the set value.

Procedure

1. Refer to "4.15.1 Change to a maintenance mode" and display the maintenance menu.
2. Press the  key to select "ALARM" and "HDOP" in order.
3. Press the  key to select "OFF", or "OVER," and press the  key.
4. Select "OVER" and enter a HDOP value by using  and press .
5. Set an buzzer sound and screen back light by referencing "4.12.8 Setting a buzzer sound and screen back light".

4.12.8 Setting a buzzer sound and screen back light

An buzzer sound and the color of the screen back light at the occurrence of an alert can be set. When the back light color under the normal condition is set to white, the color is changed to orange and when the back light color is set to orange, the color is changed to white.





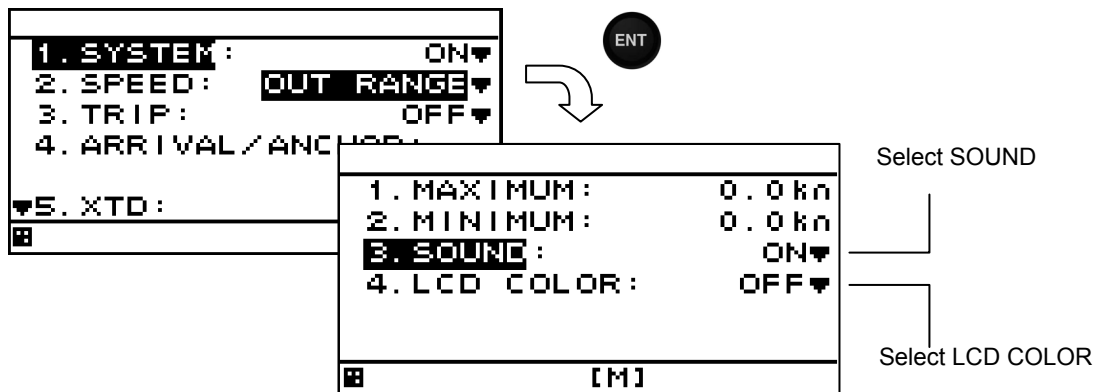

Change of a back light color cannot be performed by DGPS alert.

- 1) SOUND ON: When an alert occurs, the buzzer sound is emitted.
OFF: Even if an alert occurs, the buzzer sound is not emitted.
- 2) LCD COLOR ON: When an alert occurs, the back light color of the screen is changed.
OFF: Even if an alert occurs, the back light color of the screen is not changed.

Procedure

1. Display an alert setting screen by referencing "4.12 Setting Alert".



2. Select "SOUND" by using .
3. Select "ON" or "OFF" by using  and press .
4. Select "LCD COLOR" by using .
5. Select "ON" or "OFF" by using  and press .

4.13 GPS/Beacon/SBAS Settings

- Select "SENSOR" on the main menu to display the GPS/beacon/SBAS setting screen. The items that can be set will vary depending on the connected sensor.
- The unit must be placed in maintenance mode to change the GPS/Beacon/SBAS settings.

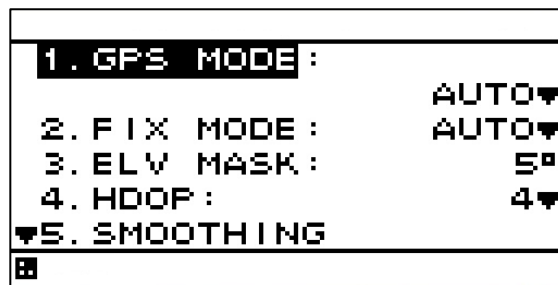

An overview of each submenu is as follows.

- (1) GPS MODE: You can select AUTO, GPS alone, Beacon, or SBAS.
- (2) FIX MODE: You can select AUTO, 2D, or 3D.
- (3) ELV MASK: You can select from 5 to 89 degrees.
- (4) HDOP: You can select 4, 10, or 20.
- (5) SMOOTHING: You can set position, speed and course smoothing.
- (6) RAIM ACCURACY: You can set the RAIM accuracy level used.
- (7) INITIALIZATION: You can perform sensor initialization.
- (8) BEACON: You can perform beacon setting.
- (9) SBAS: You can perform SBAS setting.



Supplement

- RAIM
RAIM is an abbreviation of Receiver Autonomous Integrity Monitoring. This function allows the sensor to determine whether the position accuracy measured by the GPS is within required accuracy.

4.13.1 Setting GPS Mode

- You can select AUTO, GPS alone, beacon DGPS or SBAS for GPS mode.
- The sensor must support SBAS to use SBAS positioning mode.
The selections are as follows:
 - (1) AUTO: The best positioning method is selected from GPS along, SBAS, and beacon DGPS.
 - (2) GPS ALONE: Positioning is performed using only the GPS. SBAS positioning and beacon-based DGPS positioning are not performed.
 - (3) SBAS: Positioning is performed using SBAS or GPS alone. Beacon-based DGPS positioning is not performed.
 - (4) BEACON: Positioning is performed using beacon-based DGPS or GPS alone. SBAS positioning is not performed.



Procedure

1. Refer to "4.15.1 Change to a maintenance mode" and display the maintenance menu.
2. Press the  key to select "SENSOR" and "GPS MODE."
3. Press the  key to select the GPS mode, and then press the  key.

4.13.2 Setting FIX Mode

- You can select FIX mode to AUTO, 2D, or 3D.
The selections are as follows:
 - (1) AUTO: Positioning mode is automatically switched between 3D and 2D, with the optimal method being used.
 - (2) 2D: 2D positioning performed.
 - (3) 3D: 3D positioning performed.



Procedure

1. Refer to "4.15.1 Change to a maintenance mode" and display the maintenance menu.
2. Press the  key to select "SENSOR" and "FIX MODE."
3. Press the  key to select the FIX mode, and then press the  key.

4.13.3 Setting Elevation Mask

- If the elevation mask is set, satellites at an elevation lower than the set value will not be used in positioning.
- The elevation mask can be set between 5 and 89 degrees.



Procedure

1. Refer to "4.15.1 Change to a maintenance mode" and display the maintenance menu.
2. Press the  key to select "SENSOR" and "ELV MASK."
3. Press the  key to set the Elevation mask value, and then press the  key.

4.13.4 Setting HDOP

- If HDOP is set, positioning is only performed if HDOP is lower than the set value.
- HDOP can be set to 4, 10, or 20.

Procedure

1. Refer to "4.15.1 Change to a maintenance mode" and display the maintenance menu.
2. Press the  key to select "SENSOR" and "HDOP."
3. Press the  key to select the HDOP, and then press the  key.





4.13.5 Setting Position, Speed, and Course Smoothing

- Smoothing can be applied to measured positions, speeds, and courses.
- The higher the smoothing value, the smoother the results will be, but the greater time lag. Conversely, if the smoothing value is set low, a great number of changes will occur, but there will be little time lag. As such, it is important to choose the optimal value for your own usage situation.
- Smoothing values can be set between 0 and 99 seconds.
- Smoothing can be set individually for position, speed, and course on the JLR-4341.



Procedure

1. Refer to "4.15.1 Change to a maintenance mode" and display the maintenance menu.
2. Press the  key to select "SENSOR" and "SMOOTHING."

(1) When position, speed, and course can be individually set (JLR-4341)

3. Press the  key to select "POSITION", "SPEED" or "COURSE", and press the  key.
4. Press the  key to enter the smoothing value, and press the  key.

(2) When position, speed, and course cannot be individually set (Except JLR-4341)

3. Press the  key to enter the smoothing value, and press the  key.



Supplement

- Setting a high smoothing level to position and speed can cause the sensor to react slowly to fast turns and sudden speed changes. A setting of less than 10 seconds is recommended for normal circumstances. The default value is 10 seconds. Higher settings must be used in caution.

4.13.6 Setting RAIM

- Receiver autonomous integrity monitoring (RAIM) is an integrity monitoring that determines if GPS accuracy is within the performance standards to provide an integrity indication. The integrity indications with a confidence level above 95% for different position accuracy levels are expressed in two states: "safe" and "unsafe."
In the case of the confidence level under 95%, the indication is expressed "caution."
SAFE: Position error is within the selected accuracy level.
CAUTION: Calculation cannot be performed at the selected accuracy level.
UNSAFE: Position error exceeds the selected accuracy level.
- You can set the RAIM accuracy level.
- You can select "OFF," "10m," "30m," "50m," or "100m" for accuracy levels.
Set to 30 m or greater when GPS-only positioning is performed.
If GPS-only positioning is performed with a setting of 10 m, then the 95% reliability condition will not be met, and a "CAUTION" may occur.
- If you set accuracy level to "- - -m" is displayed on the screen and the RAIM function will turn off. In "OFF" status, no calculations as to the integrity status of satellites are made.

Procedure

1. Refer to "4.15.1 Change to a maintenance mode" and display the maintenance menu.
2. Press the  key to select "SENSOR" and "RAIM ACCURACY."
3. Press the  key to select the accuracy level value, and press the  key.

4.13.7 Initializing the GPS



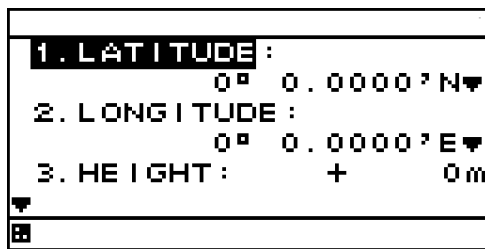

- GPS initialization can be performed.



- An overview of submenus on the GPS initialization screen is as follows.
 - (1) LATITUDE: Enter the approximate ship latitude.
 - (2) LONGITUDE: Enter the approximate ship longitude.
 - (3) HEIGHT: Enter the estimated height above the draft line of the sensor. This height is used in 2D positioning. It is not used in 3D positioning.
 - (4) DATE: Enter the current date in UTC.
 - (5) TIME: Enter the current time in UTC.

When you perform initial setting, be sure to carry out all item input.

Procedure

1. Refer to "4.15.1 Change to a maintenance mode" and display the maintenance menu.
2. Press the  key to select "SENSOR" and "INITIALIZATION."
3. Press the  key to select the items to be set, enter each value, and press the  key.
4. Press the  key to select "SEND", and press the  key.

4.13.8 Setting Beacon

Beacon setting can be performed.

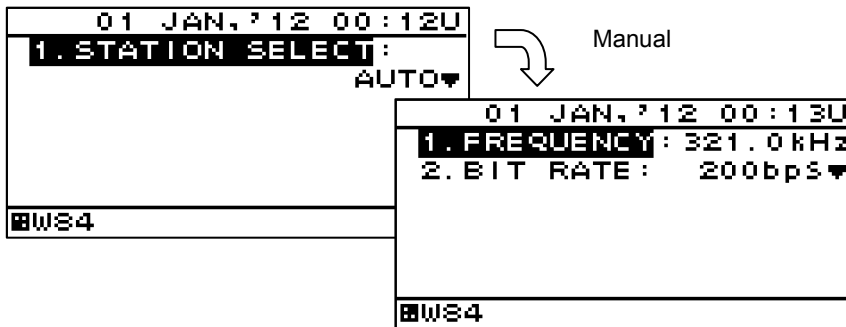



- An overview of submenus on the beacon setting screen is as follows.
 - (1) STATION SELECT: Set the beacon station selection method.
 - AUTO: The best beacon station is selected automatically from the GPS position.
 - MANUAL: You can set the frequency and bit rate manually.
 - (2) FREQUENCY: Set the frequency when station selection is set to manual.
 - (3) BIT RATE: Set the bit rate when station selection is set to manual.

Procedure



1. Refer to "4.15.1 Change to a maintenance mode" and display the maintenance menu.
2. Press the  key to select "SENSOR" and "BEACON."

(1) Setting beacon station



3. Press the  key to select "STATION SELECT."
4. Press the  key to select the method, and press the  key.

When selecting a station manually, set up the frequency and the bit rate.

(2) Setting frequency

3. Press the  key to select "FREQUENCY."
4. Press the  key to set the frequency, and press the  key.

(3) Setting bit rate

3. Press the  key to select "BIT RATE."
4. Press the  key to select the bit rate, and press the  key.

4.13.9 Setting SBAS

SBAS setting can be performed.
The sensor must support SBAS to perform SBAS setting.

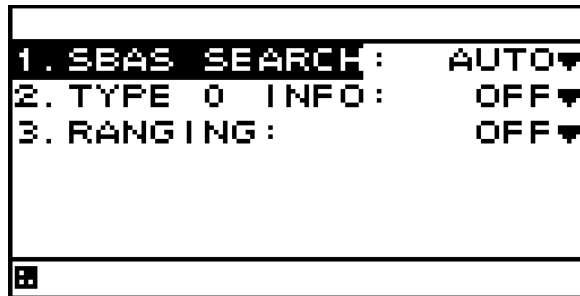



- An overview of submenus on the SBAS setting screen is as follows.
 - (1) SBAS SEARCH: The SBAS satellite can be set.
 - AUTO: The SBAS satellite is automatically set.
 - SBAS Satellite number: The SBAS satellite number is set manually.
 - (2) TYPE 0 INFO: Set whether test broadcast data is used.
 - ON: Used.
 - OFF: Not used (default).
 - (3) RANGING: Set whether SBAS satellite is used for positioning in the same way as the GPS satellite.
 - ON: Used.
 - OFF: Not used (default).



Procedure

1. Refer to "4.15.1 Change to a maintenance mode" and display the maintenance menu.
2. Press the  key to select "SENSOR" and "SBAS."



(1) Setting SBAS satellites

3. Press the  key to select "SBAS SEARCH."
4. Press the  key to select the search method, and press the  key.



The SBAS satellite number can be selected manually.

Press the  key to select the SBAS satellite number, and press the  key.

(2) Setting type 0 information

3. Press the  key to select "TYPE 0 INFO."
4. Press the  key to select "ON" or "OFF," and press the  key.

(3) Setting ranging



3. Press the  key to select "RANGING."
4. Press the  key to select "ON" or "OFF," and press the  key.

4.14 Beacon Information

When the beacon information is set to "ON" based on "4.13.8 Setting beacon", the beacon information (Type16 message) from the beacon broadcast stations can be displayed.



Procedure

1. Refer to "4.15.1 Change to a maintenance mode" and display the maintenance menu.
2. Press the  key to select "BEACON."
3. Press the  key to select "ON." and press the  key.

4.15 Equipment Configuration

After completing the installation that is described in Chapter 6, check the operation and set the details. In the installation setting, implement the following operations according to the system specification of the vessel.



- 1) Changing to a maintenance mode
- 2) Setting a model
- 3) Selecting a dimmer unit
- 4) Setting dimmer control linkage and data sharing
 - Setting RS-485ID
 - Setting a dimmer group
 - Setting data sharing
- 5) Setting an interface
- 6) Setting a sub display unit
- 7) Setting a display screen

4.15.1 Changing to a maintenance mode

Before starting installation, the mode must be changed to a maintenance mode to prevent an operation error.



Change the mode to a maintenance mode by the initial operation.

Procedure

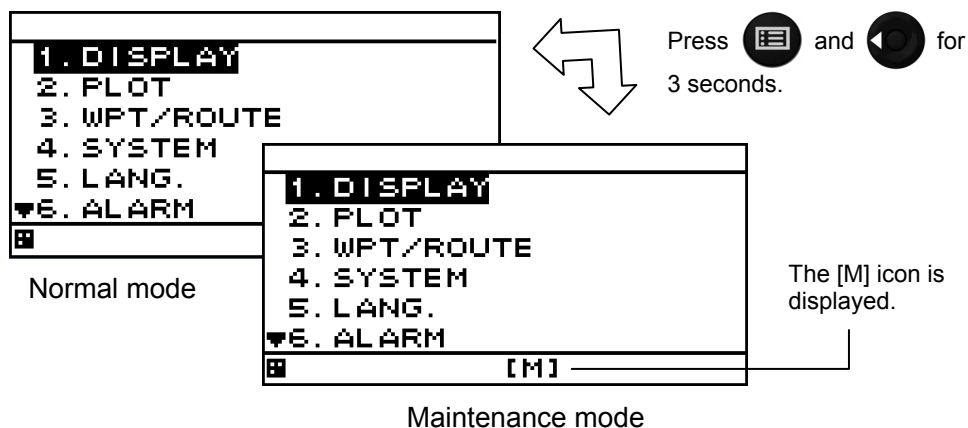
1. Display a main menu by pressing  (normal mode).
2. Press  and  for 3 seconds.
3. The menu is changed to a maintenance menu (maintenance mode).
When the mode is changed to a maintenance mode, the [M] icon is displayed at the bottom of the screen.



- Returning to a normal mode

When  and  are pressed for 3 seconds or no operation is performed for 3 minutes, the mode is reset to a normal mode.

When the power is turned on, the system starts in normal mode.





4.15.2 Setting a model

Set this display unit as a GPS display unit.

When the model is set, the setting contents are initialized.

When setting up to "GPS" by model setup, perform receiver selection like the first time power ON (refer to "4.2.1 Turning the Unit On").

Procedure

1. Refer to "4.15.1 Change to a maintenance mode" and display a maintenance menu.
2. Select "16.DISPLAY TYPE" by using  and press .
3. Select "GPS" by using  and press .
4. When the following popup menu is displayed, press "YES".
When "NO" is selected, the model setting is cancelled.

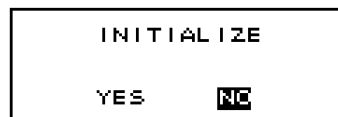

Supplement

- When "LOG" is selected wrong, the following messages appears.

After the messages appears, press  and  for 8 seconds. The message is canceled.

Then, select "MID" again in the previous procedure.

Please turn on
the power again.

- Don't turn off the power supply until the "INITIALIZING" disappears.

4.15.3 Selecting a dimmer unit



Specify whether an external dimmer unit (NCM-227) or a dimmer key is used for controlling the dimmer unit of this display unit.

When an external dimmer unit is used, the contact point input must be set to "DIMMER". For the setting method, see "4.15.6 Setting Contact Input".

When sharing a dimmer unit, set the same dimmer unit for the display units that share the dimmer unit. Unless the same dimmer unit is set, linking cannot be performed.

To calibrate the external dimmer unit, refer to "7.1 Calibration of External dimmer unit" in service manual.

Procedure

1. Refer to "4.15.1 Change to a maintenance mode" and display a maintenance menu.
2. Select "DIMMER" by using .
3. Select a dimmer unit by using  and press .

4.15.4 Dimmer linked control and data sharing with RS-485

By connecting display units with RS-485 network, dimmer control can be linked and data can be shared.

To connect display units with RS-485 network, the display units must be identified by setting RS-485ID in each display unit.

Up to 10 display units can be connected.

The same baud rate must be set for all the display units. Normally, the baud rate is set to 115200bps.

It is possible to select key control or control by an external dimmer unit for dimmer control. Display units that are linked can be selected by classifying display units under dimmer control into groups.

However, the same control method such as key control or control using an external dimmer unit must be applied among the display units that are linked. Up to 10 groups are allowed.

Data can be shared by outputting a NMEA sentence to the RS-485 network.

By sharing data, the same data can be displayed.

A typical connection example for implementing dimmer control and data sharing with RS-485 is shown below. Refer to the setting reference section for the setting method.

The connection conditions of the connection example are as follows.

		Display unit 1	Display unit 2	Display unit 3	Display unit 4	Setting reference section
RS-485ID		1	2	3	4	4.15.4.1
Dimmer control unit		External dimmer unit	External dimmer unit	Dimmer key	Dimmer key	4.15.3
Dimmer group		1	1	2	2	4.15.4.3
Input data	GPS	-	-	-	LAT/LON	4.15.5.2
	RS-485	LAT/LON	LAT/LON	LAT/LON	-	-
Output data	RS-485	-	-	-	LAT/LON	4.15.4.4
Baud rate [bps]		115200	115200	115200	115200	4.15.4.4
Screen display		LAT/LON	LAT/LON	LAT/LON	LAT/LON	4.9.4
Display type		MID	MID	MID	MID	4.15.2

In this example, dimmer control of ID1 and that of ID2 are linked by the external dimmer unit and dimmer control of ID3 and ID4 are not linked.

Dimmer control of ID3 and that of ID4 are linked by key operation and dimmer control of ID1 and that of ID2 are not linked.

By transmitting LAT/LON data that is input from ID4 through the RS-485 network, LAT/LON data can be displayed on all the display units.

Connection example

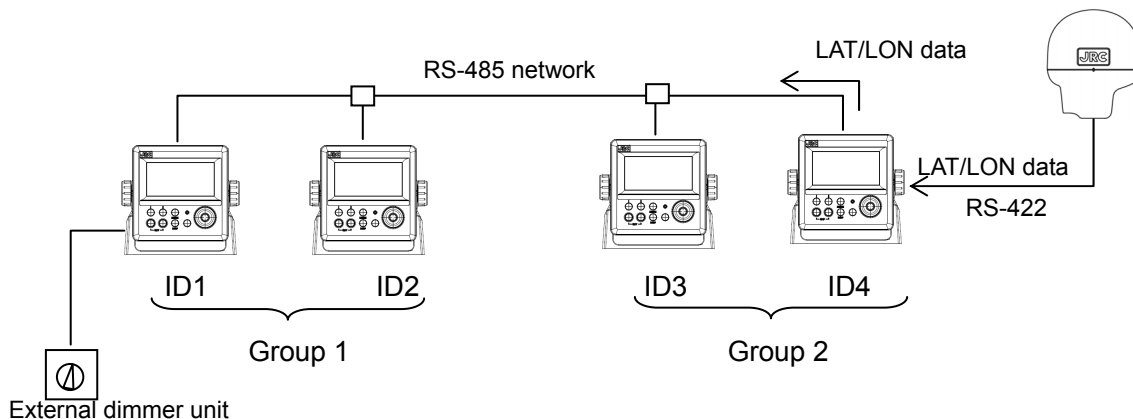



4.15.4.1 Setting RS-485ID

To identify a display unit on the RS-485 network, set an ID for each display unit.

To use RS-485, an ID must be set.

Avoid duplication of ID among the display units. Otherwise, data and dimmer linkage are not possible. Available IDs are from 1 to 10.

Procedure

1. Refer to "4.15.1 Change to a maintenance mode" and display a maintenance menu.
2. Select "RS-485ID" by using .
3. Enter an ID number by using  and press .

4.15.4.2 Linking dimmer control

Dimmer control linkage is available for the display units that are connected by the RS-485 network.

The following conditions are necessary for the linkage.

- 1) The display units must be connected by RS-485.
- 2) The same dimmer control is used.
- 3) The display units are in the same dimmer group.

Set the details by referencing the following sections.

- 1) Set RS-485ID by referencing "4.15.4.1 Setting RS-485ID".
- 2) Select the same dimmer unit by referencing "4.15.3 Selecting a dimmer unit".
- 3) Set the display units in the same dimmer group by referencing "4.15.4.3 Setting a dimmer group".

To disable linkage of dimmer control even though the display unit is connected by the RS-485 network, change the dimmer group.

Supplement

Since dimmer data is transmitted between display units, some time lag may occur at dimmer switching.

4.15.4.3 Setting a dimmer group



Set a group within which dimmer control for this display unit is linked.

Available dimmer group numbers are from 1 to 10.

Set a dimmer group when the display units for which dimmer control is to be linked need to be grouped due to the different equipment environment even though the units are connected by RS-485.

Select the same dimmer unit within the same group. Otherwise, dimmer control cannot be linked within the group.

Procedure

1. Refer to "4.15.1 Change to a maintenance mode" and display a maintenance menu.
2. Select "DIMMER GROUP" by using .
3. Enter a group number by using  and press .

4.15.4.4 Sharing data

Data can be shared among the display units that are connected through the RS-485 network. Set the data to be transmitted. Although setting for reception is not necessary, the baud rate must be standardized among the display units.

For the linkage, set RS-485ID by referencing "4.15.4.1 Setting RS-485ID".

Setting transmission

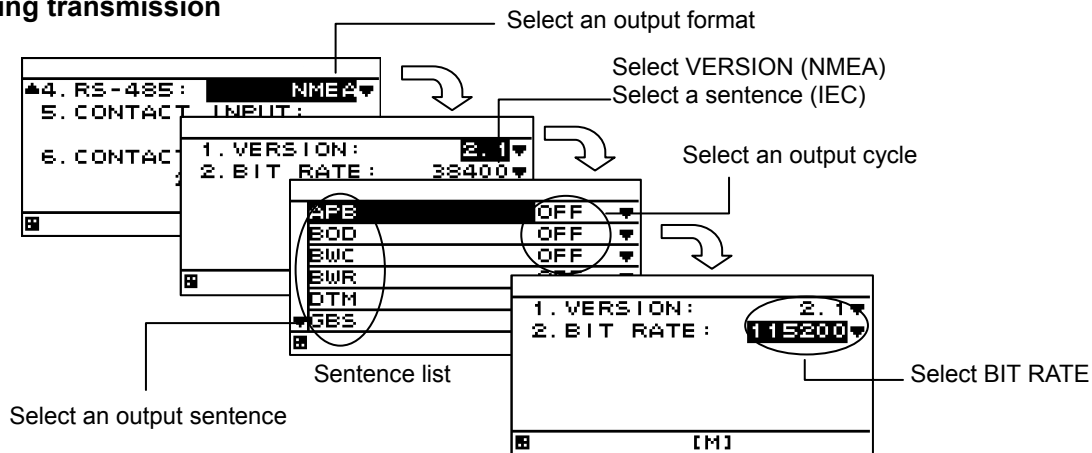

Procedure

1. Refer to "4.15.1 Change to a maintenance mode" and display a maintenance menu.
2. Select "INTERFACE", "DATA I/O", and "RS-485" in this order by using
3. Select the output format to be set by using
- 1) Selecting NMEA
4. When an output version is selected by using , a sentence list is displayed.
Available versions are "1.5", "2.1", "2.3", and "4.0".
5. Select an output sentence by using and set an output cycle.
A cycle can be selected within the range from 1 second to 9 seconds and if OFF is selected, the sentence is not output.
6. Return control to the BIT RATE selection screen and select BIT RATE by using .
Available bit rates are "38400", "57600", "76800", and "115200". Normally, "115200" is recommended.
- 2) Selecting IEC
- In IEC, VERSION is not selected.
4. When "SENTENCE" is selected by using , a sentence list is displayed.
5. Select an output sentence by using and set an output cycle.
A cycle can be selected within the range from 1 second to 9 seconds and when OFF is selected, the sentence is not output.
6. Return control to the BIT RATE selection screen and select BIT RATE by using .
Available bit rates are "38400", "57600", "76800", and "115200". Normally, "115200" is recommended.

Supplement

Since data is transmitted between display units, some time lag occurs at the switching of display.

When the bit rate is set to 115,200bps (Max speed), up to 4 sentences can be output.

4.15.5 Setting a serial port

This display unit is equipped with three serial ports to send and receive data with external units. Since each port can be set for input or output, set according to the purpose. However, as input/output of data IN/OUT1 and data IN/OUT2 are commonly set, they cannot be set individually.

For instance, if data IN/OUT2 is set for input, data IN/OUT1 is automatically set for input.

In this case also, the baud rate and the output sentence can be set individually.

Determine the input output ports using the following table as the guideline.

Required port setting	Port setting		
	Data IN/OUT1	Data IN/OUT2	Data IN/OUT3
3 ports for output	Output	Output	Output
3 ports for input	Input	Input	Input
2 ports for output 1 port for input	Output	Output	Input
1 port for output 2 ports for input	Input	Input	Output

Although an output sentence, a cycle, and a bit rate can be set for each port, some bit rates and the number of sentences may not be set. In this case, select the minimum sentence.

The following serial data can be set.





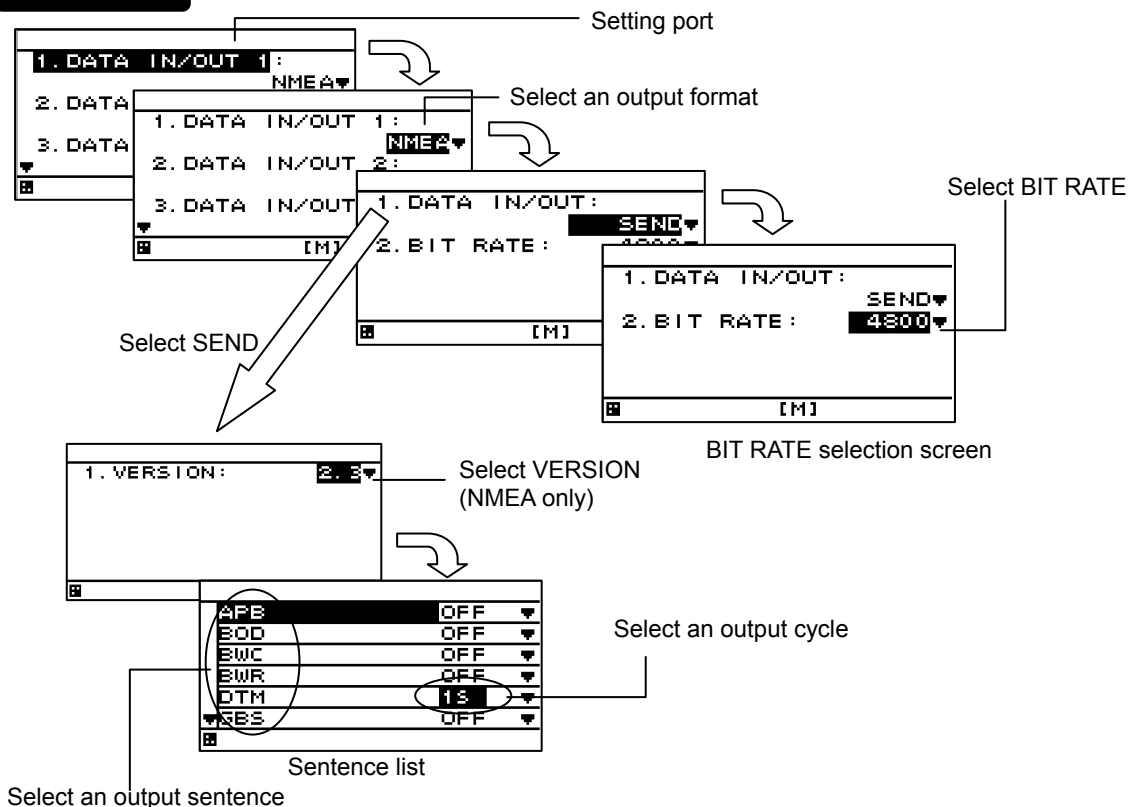

- 1) NMEA: Data is output in NMEA format. Available options are Version 1.5, 2.1, 2.3, and 4.0.
- 2) IEC: Data is output in IEC format.
- 3) JRC : Data is output in JRC format. The bit rate is fixed 1200bps.
- 4) ROUTE WPT : The destination, route, and track in a memory can be transmitted and received using DATA IN/OUT2, 3. (Refer to 4.15.17 Outputting Waypoint, Route and Track" for detail)

4.15.5.1 Setting transmission

The procedure for setting a serial port for transmission is shown below.



Procedure



1. Refer to "4.15.1 Change to a maintenance mode" and display a maintenance menu.
 2. Select "INTERFACE" and "DATA I/O" in this order by using .
 3. Select the output format to be set by using .
- 1) Selecting NMEA
 4. Select "SEND" from "DATA IN/OUT" by using .
 5. When an output version is selected by using , a sentence list is displayed.
Available versions are "1.5", "2.1", "2.3", and "4.0".
 6. Select an output sentence by using  and set an output cycle.
A cycle can be selected within the range from 1 second to 9 seconds and if OFF is selected, the sentence is not output.
 7. Return control to the BIT RATE selection screen and select BIT RATE by using .

Available bit rates are "4800", "9600", "19200", and "38400".
 - 2) Selecting JRC
 4. Select an output cycle by using  and set an output cycle.
A cycle can be selected only 4 seconds and if OFF is selected, the sentence is not output.
The JRC format can not be select version, bit rate and sentence.
The bit rate is fixed 1200bps.
 - 3) Selecting IEC

For IEC, there is no need to select VERSION.

 4. Select "SEND" from "DATA IN/OUT" by using .
 5. Select an output sentence by using  and set an output cycle.
The cycle can be selected within the range from 1 second to 9 seconds and when OFF is selected, the sentence is not output.
 6. Return control to the BIT RATE selection screen and select BIT RATE by using .

Available bit rates are "4800", "9600", "19200", and "38400".

Supplement

When the "SEND" or "RECEIVE" of data IN/OUT1 or data IN/OUT2 is set and one port is set, the other port is also set concurrently. The message that is shown below is displayed to prevent the unintentional setting of the other port. When setting a port, select "YES". If "NO" is selected, the port is not set.

```





      SET DATA
      IN/OUT 1AND2 OK?
      YES    NO
  
```

4.15.5.2 Setting reception

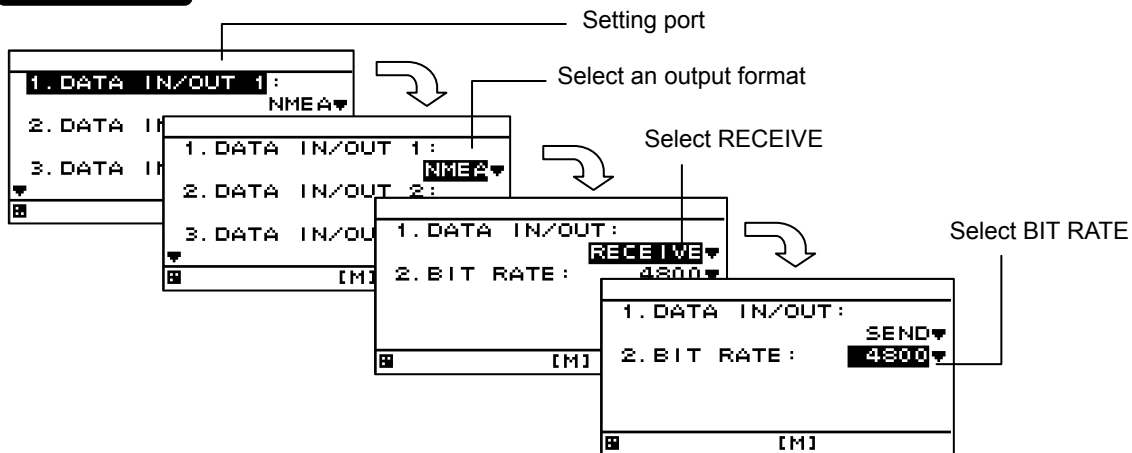
In the reception setting, set a baud rate.
A JRC format cannot be selected as the format.
There is no need to set a sentence or a cycle.

Procedure



1. Refer to "4.15.1 Change to a maintenance mode" and display a maintenance menu.
 2. Select "INTERFACE" and "DATA I/O" in this order by using .
 3. Select a port and an output format that are to be set by using .
 4. Select "RECEIVE" from "DATA IN/OUT" by using .
 5. Return control to the BIT RATE selection screen and select BIT RATE by using .
- Available bit rates are "4800", "9600", "19200", and "38400".

Supplement

When the "SEND" or "RECEIVE" of data IN/OUT1 or data IN/OUT2 is set and one port is set, the other port is also set concurrently. The message that is shown below is displayed to prevent the unintentional setting of the other port. When setting a port, select "YES". If "NO" is selected, the port is not set.

```
SET DATA
IN/OUT 1AND2 OK?
YES NO
```



4.15.6 Setting Contact Input

A contact input port can be set to the following input.

- 1) DIMMER: Use this option when connecting an external dimmer unit.
- 2) ACK: ACK is input from an external unit.

To use an external dimmer unit, the dimmer unit must be set to "EXT DIMMER". Refer to "4.15.3 Selecting a dimmer unit" for the setting method.

Procedure

1. Refer to "4.15.1 Change to a maintenance mode" and display a maintenance menu.
2. Select "INTERFACE", "DATA I/O" and "CONTACT INPUT" in this order by using .
3. Select an item to be input by using  and press .



4.15.7 Setting Contact Output

- The following contact outputs can be set for contract output: Log Pulse (200 pulse/NM), Log Pulse (400 pulse/NM), and Alert.

An overview of the contact output submenu is as follows.

- 1) LOG(200p/NM): 200 pulse/NM log pulse is output.
- 2) LOG(400p/NM): 400 pulse/NM log pulse is output.
- 3) ALARM: Operates as a contact alert when an alert has been generated.
- 4) OFF: Not operate.

Procedure

1. Refer to "4.15.1 Change to a maintenance mode" and display the maintenance menu.
2. Press the  key to select "INTERFACE," "DATA I/O," and "CONTACT OUTPUT" in order.
3. Press the  key to select the state for which you want contact operation, and press the  key.

4.15.8 Outputting Alert history



Alert history can be output to an external unit.

Data is output from a data IN/OUT1 port.

If data IN/OUT1 is set to reception, the port must be set to transmission.

Connect PC to a serial port before output operation.

Procedure

1. Refer to "4.15.1 Change to a maintenance mode" and display the maintenance menu.
2. Refer to "4.15.5.1 Setting transmissin" to set DATA IN/OUT1 to "SEND."
3. Press the  key to select "INTERFACE" and "DIAGNOSIS" in order.
4. Select "ERROR LOG OUT" and press the  key. Alert history is output to an external unit.

Supplement

When DATA IN/OUT1 is used by setting to transmission, port setting is not required.
The alert history is outputted between normal output sentences.

4.15.9 Checking installation

Installation can be checked.

The following items can be checked.

- 1) Checking the input port
- 2) Self-diagnosis
- 3) Display of alert history
- 4) Confirmation of software version and serial number

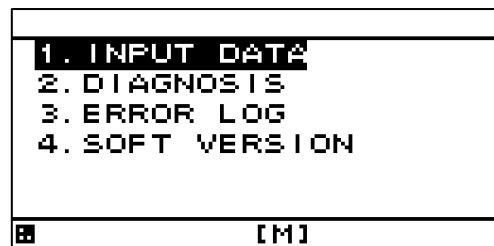







Supplement

- See "4.15.8 Outputting alert history" for external output of alert history.
- See "4.15.14 Outputting Setting value" for external output of setting value.
- See "4.15.11 Demonstration" for setting a demo mode for confirmation of data output.

4.15.9.1 Checking the input port

Data that is received from the serial port can be displayed on a screen. The serial port and display format (ASCII/BINARY) can be selected. Data of the serial port that is set to output cannot be displayed.

Procedure

1. Refer to "4.15.1 Change to a maintenance mode" and display a maintenance menu.
2. Select "MAINTENANCE" and "INPUT DATA" in this order by using  and press .
An operation description screen is displayed as shown below.
3. To change the display format press . The format changes between ASCII and BINARY.
4. Select the port whose data is to be displayed by using  and press . The received data is displayed on the screen. To cancel the display press  again.
During cancellation, the blinking of the * mark is stopped.
To back to the operation description screen, press .



When no data is displayed, check the connection and the setting of the serial port.

4.15.9.2 Self-diagnosis

Self-diagnosis of the display unit can be performed and the result can be displayed. The following items can be diagnosed.



- 1) ROM, RAM, and serial port of the display unit
- 2) Sensor (Only JLR-7900)
- 3) Monitor (LCD)

The entire screen is highlighted repeatedly such as black to white, white to black. Check if some dots are omitted.

- 4) Buzzer sound

Checks if the buzzer sounds.

Procedure



1. Refer to "4.15.1 Change to a maintenance mode" and display a maintenance menu.
2. Select "MAINTENANCE" and "DIAGNOIS" in this order by using .
3. Select a diagnosis item by using  and press . The diagnosis is executed and the result is displayed.

If you wish to stop the monitor check, press .

4.15.9.3 Displaying an alert

The current alert and past alerts can be displayed. Up to 40 past alerts can be stored and when the number of alerts exceeds 40, alerts are deleted from the oldest one.

Procedure



1. Refer to "4.15.1 Change to a maintenance mode" and display a maintenance menu.
2. Select "MAINTENANCE" and "ERROR LOG" in this order by using .
- Displaying the current alert
3. Select "ALARM" by using  and press .

The current alert is displayed.

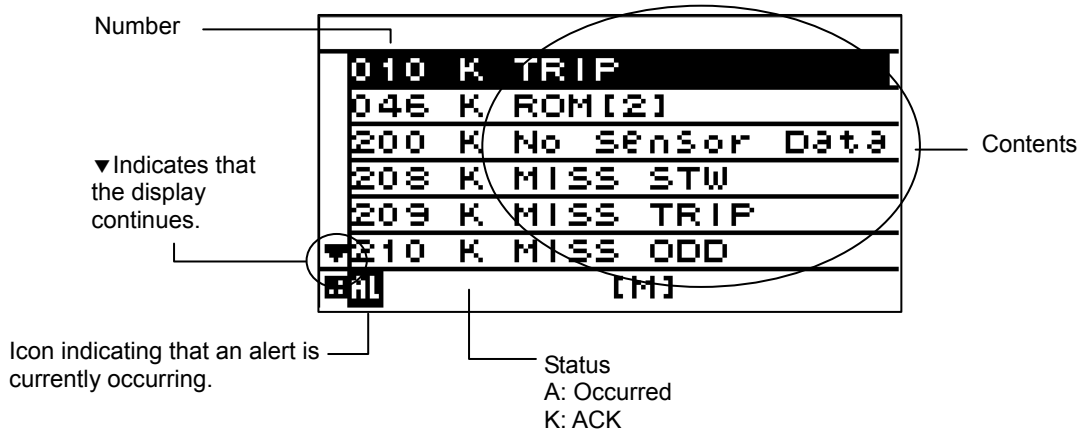
When no alert has occurred, no information is displayed.



- Displaying past alert history

4. Press "ERROR LOG" by using  and press .

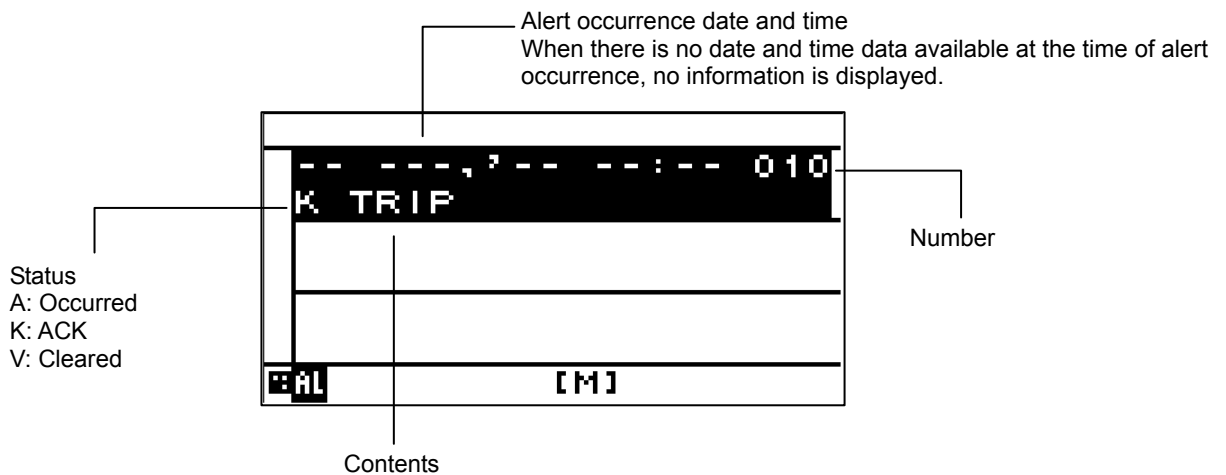

4.15.9.4 Displaying the software version

The software version, serial number and bar code number of the display and sensor unit can be displayed.

It is only JLR-4341/JLR-4340 that the serial number and bar code number of the sensor unit can be displayed.

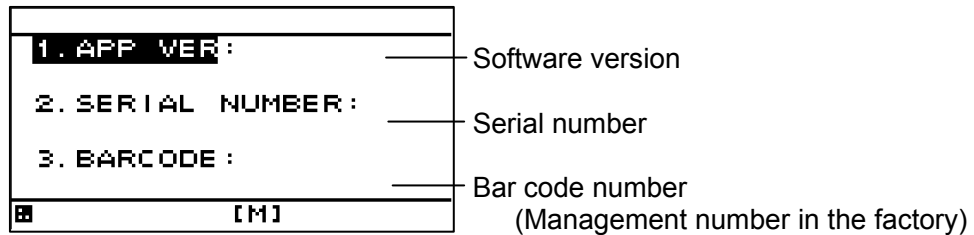

Procedure

1. Refer to "4.15.1 Change to a maintenance mode" and display a maintenance menu.
 - 1) Display
 2. Select "MAINTENANCE", "SOFT VERSION", and "DISPLAY VER" in this order by using
- 2) Sensor
 2. Select "MAINTENANCE", "SOFT VERSION", and "SENSOR VERSION" in this order by using

4.15.10 Performing a Master Reset (Reset)

The GPS sensor, display or both can be reset

When master reset is performed, the setting values are reset to the default values. It is recommended to keep the records of the setting values before performing master reset.

However, the following items are not reset.

Model, RS-485ID, dimmer control unit setting, dimmer group

To reset the display, select "DISPALY" or EXCEPT FOR LIST"

Master reset can be selected for the following equipment.

- 1) DISPLAY RESET: The display unit is reset.
 - DISPLAY: Everything (include the waypoint and route klist) will be reset
 - EXCEPT FOR LIST: Everything (except the waypoint and route klist) will be reset
- 2) RECEIVER RESET: Sensor unit is reset.
- 3) ALL RESET: The sensor and display unit (including list) is reset

Procedure

1. Refer to "4.15.1 Change to a maintenance mode" and display the maintenance menu.
2. Press the key to select "MASTER RESET," and press the key.
3. Press the key to select equipment and press the key.
 - 1) DISPLAY only (including list)
 4. Select "DISPLAY RESET" and "DISPLAY" in order.
 - 2) DISPLAY only (other than list)
 4. Select "DISPLAY RESET" and "EXCEPT FOR LIST" in order.
 - 3) SENSOR only
 4. Select "RECEIVER RESET".
 - 3) SENSOR and DISPALY
 4. Select "ALL RESET".





4.15.11 Performing a Demo

Through a demonstration, display and external output are enabled in the same way as the actual equipment operation.

The following demo types can be set.

- 1) STATIC: Remains stationary.
- 2) STRAIGHT: Goes in straight lines. Set the speed and direction.
- 3) RIGHT: Turns right. Set the speed and turn radius.
- 4) LEFT: Turns left. Set the speed and turn radius.
- 5) ROUTE: Performs selected route
- 6) AUTO: Moves in set direction a set distance from set position.

Procedure

1. Refer to "4.15.1 Change to a maintenance mode" and display the maintenance menu.
2. Press the  key to select "DEMO MODE" and "DEMO TYPE" in order.
3. Press the  key to select "DEMO TYPE" and press the  key.
4. Press the  key to enter the init
5. Enter "DATE", "TIME", "LATITUDE" and "LONGITUDE".
6. Press the  key to select "DEMO MODE." Set "START."

Supplement

When the demo is being performed, [S] will blink at the bottom of the screen.
To stop the demo, set "END" to "DEMO MODE" or turn the power off.





4.15.12 Setting the Sub Display

The display unit can be used as SUB-Display

If the display set to sub display, it can not be set to GPS sensor unit

If you set to "MAIN", the display unit can be used as MAIN-Display

Procedure

1. Refer to "4.15.1 Change to a maintenance mode" and display the maintenance menu.
2. Press the  key to select "MAIN/SUB" and press the  key.
3. Press the  key to select "SUBSTITUTE" and press the  key.
4. When the following popup menu is displayed, press "YES".



ARE YOU SURE ?
OK CANCEL

5. The display unit is restart automatically

4.15.13 Setting the GPS Sensor Number

- A number can be assigned to each GPS when there are two GPS sensors.
- This number used for Remote Maintenance System data, so always perform GPS number configuration.
- When only one GPS is used, set the number to No1.
- Set a number for each display type, main and sub. Sub-display are not connected to GPS sensors, but must be set.
- Always set numbers in order starting from No1.



Procedure

1. Refer to "4.15.1 Change to a maintenance mode" and display the maintenance menu.
2. Press the  key to select "RECEIVER No."
3. Press the  key to select the number, and press the  key.

4.15.14 Outputting setting value

Setting value can be output to an external unit.
Data is output from a data IN/OUT1 port.
If data IN/OUT1 is set to reception, the port must be set to transmission.
Connect PC to a serial port before output operation.

Procedure

1. Refer to "4.15.1 Change to a maintenance mode" and display the maintenance menu.
2. Refer to "4.15.5.1 Setting transmission" to set DATA IN/OUT1 to "SEND."
3. Press the  key to select "INTERFACE" and "DIAGNOSIS" in order.
4. Select "CONFIG OUT" and press the  key. Setting value is output to an external unit.





Supplement

When DATA IN/OUT1 is used by setting to transmission, port setting is not required. At completion of alert history, the setting is reset to the original output data automatically.

4.15.15 Setting Sensor Position / CCRP

- You can set the ship size, CCRP position, and GPS sensor position.
- The CCRP position and GPS position are set on a coordinate system with the center of the ship as the point where the axes cross.
- Set the ship size (ship length and width), and set the CCRP position and GPS sensor position.
- The set CCRP position can be output to externally connected equipment. For output, refer to "4.15.5.1 Setting transmission ", and select "PJRC,SAP,GP" or "POS" as the output sentence. To output to external equipment, the equipment must have CCRP send / receive functionality.
- CCRP cannot be set from a sub-display. Set CCRP from the main display.

Procedure

1. Refer to "4.15.1 Change to a maintenance mode" and display the maintenance menu.
2. Press the  key to select "CCRP" and press the  key.
3. Press the  key to select the ship size ("BEAM", "LENGTH"), and enter the ship size.
3. Press the  key to select the sensor position ("SENSOR X/Y/Z"), and enter the sensor position
3. Press the  key to select the CCRP position ("CCRP X/Y/Z"), and enter the CCRP position

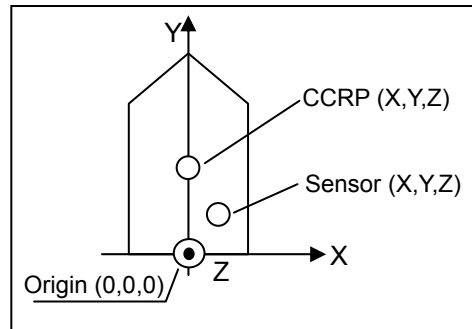





The CCRP position can be received. If the set position and received position differ, a pop up alert will occur, so please perform the settings again.

4.15.16 Calculating Trip Distance

Trip distance is calculable from a ship speed and elapsed time.
Two trip is simultaneously calculable.
In order to do trip calculation, it is necessary to select a distance screen by screen selection.

24 OCT, '11 00:06U	
TRIP1 END	TRIP2 START
RUN	
4.20 NM	0.00 NM
	

Procedure

1. Press the  key to select "START" of TRIP1 or "START" of TRIP2 and press the  key.
 2. "RUN" blinks and calculate trip.
 3. Press the  key to select "END" and press the  key.
- Trip distance is displayed until it selects "START" again.

Supplement

Trip will be cleared when a power is turned OFF.

4.15.17 Inputting/Outputting Waypoint, Route and Track

4.15.17.1 Outputting Waypoint, Route and Track

A waypoint list and the destination of a route list, a route, and a trip can be outputted to external PC. The ports used with an output are DATA IN/OUT2 and 3.

By outputting in an exclusive format, it can save by a CSV file. In order to use an exclusive format, PC tool for exclusive use is needed.

When you use PC tool for exclusive use, be sure to make the bit rate of DATA IN/OUT2 and 3 the same. When outputting by NMEA, general-purpose tools, such as a hyper-terminal, can be used. In this case, the output of a track cannot be performed. The sentences to be used are WPL and RTE.

The outline of the data which can be outputted is as follows.

ALL WAYPOINT:	Output all the waypoint.
ALL ROUTE:	Output all the route.
ALL WAYPOINT+ROUTE:	Output all the waypoint and route.
ALL TRACK:	Output all the trip.

When you output and input, connect with PC as follows. When connected with other equipment, change connection into PC temporarily.

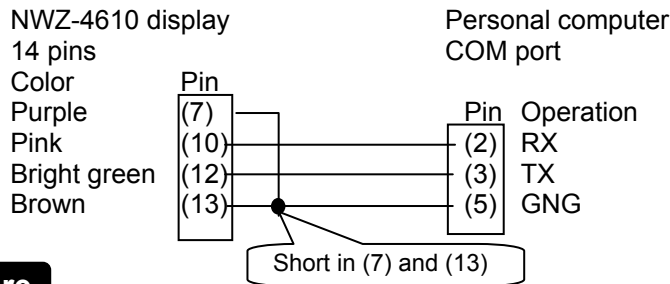





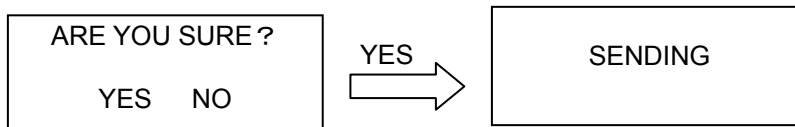

Procedure

- 1) When outputting in a NMEA format
 1. Refer to "4.15.1 Change to a maintenance mode" and display the maintenance menu.
 2. Press the key to select "INTERFACE" "DATA I/O" and press the key.
 3. Select "ROUT WPT" from DATA IN/OUT2, and press the key.
 4. Select NMEA version from "VERSION", and press the key.
 5. Select the bit rate linked with PC from "BIT RATE", and press the key.
 6. Select the data outputted from "OUTPUT DATA", and press the key.
In the case of NMEA data output, the output of "ALL TRACK" cannot be performed.
 7. Press the key to select "SEND", and press the key.
 8. Since the following is displayed, select "YES".
It is displayed as "SENDING" and data transmission is carried out.



2) When outputting in an exclusive format

1. Refer to "4.15.1 Change to a maintenance mode" and display the maintenance menu.
2. Press the  key to select "INTERFACE" "DATA I/O" and press the  key.
3. Select "ROUT WPT" from DATA IN/OUT2 and DATA IN/OUT3, and press the  key.
4. Select "JRC" from "VERSION" in DATA IN/OUT2, and press the  key.
5. Select the bit rate linked with PC from "BIT RATE" in DATA IN/OUT2 and DATA IN/OUT3, and press the  key.
6. Start the tool of PC. Refer to "4.15.17.3 How to Use Exclusive PC Tool" for how to use PC tool for exclusive use.
7. Press the  key to select "SEND" in DATA IN/OUT2, and press the  key.
8. Since the following is displayed, select "YES".
It is displayed as "SENDING" and data transmission is carried out.

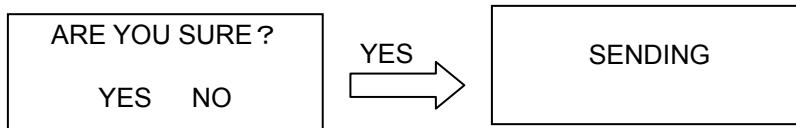

4.15.17.2 Inputting Waypoint, Route and Trip

The waypoint, a route, and a track can be inputted from external PC, and it can save on a destination list and a route list.

The ports used in an input are DATA IN/OUT2 and 3.







A CSV file can be inputted in an exclusive format. In order to use an exclusive format, PC tool for exclusive use is needed.

When you use PC tool for exclusive use, be sure to make the bit rate of DATA IN/OUT2 and 3 the same. It can also input by NMEA (WPL, RTE sentence).

When you output and input, refer to " 4.15.17.1 Outputting Waypoint, Route, and Track ", and connect with PC. When connected with other equipment, change connection into PC temporarily.

Procedure

1) When inputting in a NMEA format



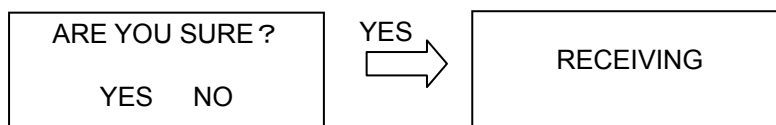



1. Refer to "4.15.1 Change to a maintenance mode" and display the maintenance menu.
2. Press the  key to select "INTERFACE","DATA I/O" and press the  key.
3. Select "ROUT WPT" from DATA IN/OUT3, and press the  key.
4. Select the bit rate linked with PC from "BIT RATE", and press the  key.
5. Press the  key to select "RECEIVE", and press the  key.
6. Since the following is displayed, select "YES".
It is displayed as "RECEIVING " and will be in the state waiting for received data.



7. NMEA data is transferred to a display from PC or external equipment.

When data is received normally, the display of "RECEIVING" will disappear and it will become reception completion.

2) When outputting in a NMEA format

1. Start the tool of PC and select a output file.
Refer to "4.15.17.3 How to Use Exclusive PC Tool" for how to use PC tool for exclusive use.
2. Refer to "4.15.1 Change to a maintenance mode" and display the maintenance menu.
3. Press the  key to select "INTERFACE","DATA I/O" and press the  key.
4. Select "ROUT WPT" from DATA IN/OUT2 and DATA IN/OUT3, and press the  key.
5. Select "JRC" from "VERSION" in DATA IN/OUT2, and press the  key.
6. Select the bit rate linked with PC from "BIT RATE" in DATA IN/OUT2 and DATA IN/OUT3, and press the  key.
7. Select "RECEIVE" from DATA IN/OUT3, and press the  key.
8. Since the following is displayed, select "YES".
It is displayed as "RECEIVING " and will be in the state waiting for received data.

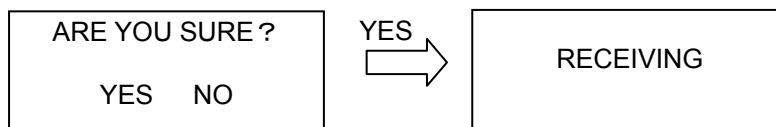

9. Press "START" on the PC Tool.
Data is transferred to a display from PC.

When data is received normally, the display of "RECEIVING" will disappear and it will become reception completion.

Supplement

It is overwritten when the destination number and route number which were inputted already exist in a display.

4.15.17.3 How to Use Exclusive PC Tool

The usage of "JrcRouteTrans.exe" which is a tool for exclusive use of the input and output of the "route, waypoint and track" are described.

(1) Preparation

Installation is unnecessary. Copy "JrcRouteTrans.exe" to arbitrary folders.

(2) When outputting from a display

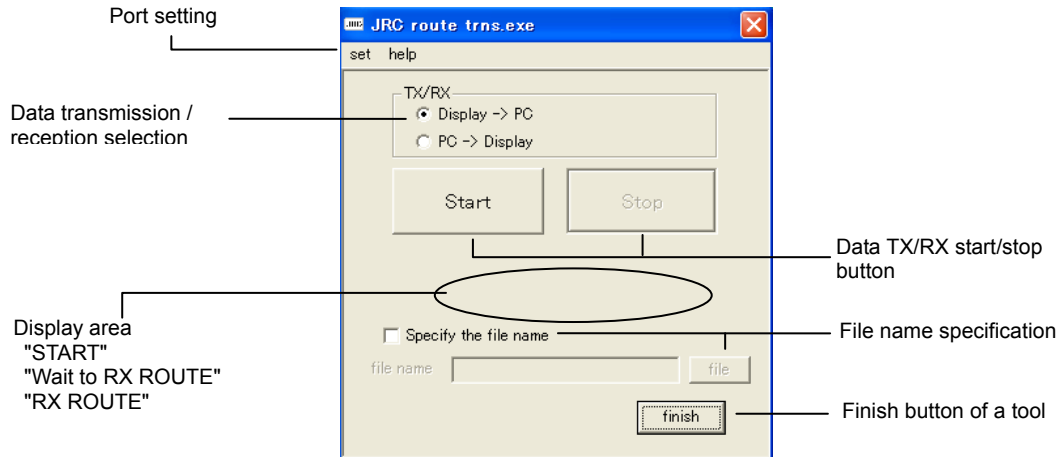

1. Select "Display=>PC" from "TX/RX".
2. Specify the file name to save.
 - 1) Put a check into "Specify the file name".
 - 2) Specify a folder by "file" and input a file name.
When not specifying, ¥JRC_ROUTE folder is generated and it is saved at "JRC_Date_Time_waypoint.(or route, track) csv."
Refer to "(4) CSV file" about a CSV file.
3. Press "Start".
It is displayed with "Wait to RX ROUTE" that it is displayed as "START."
(Also in the waypoint and track, it is displayed as "Wait to RX ROUTE".)
4. When data is received from a display, "RX ROUTE" will blink.
5. When reception is completed, it will be displayed as "Wait to RX ROUTE".
6. Press "Stop".
7. Press "finish" and terminate a tool.

(3) Input into a display.

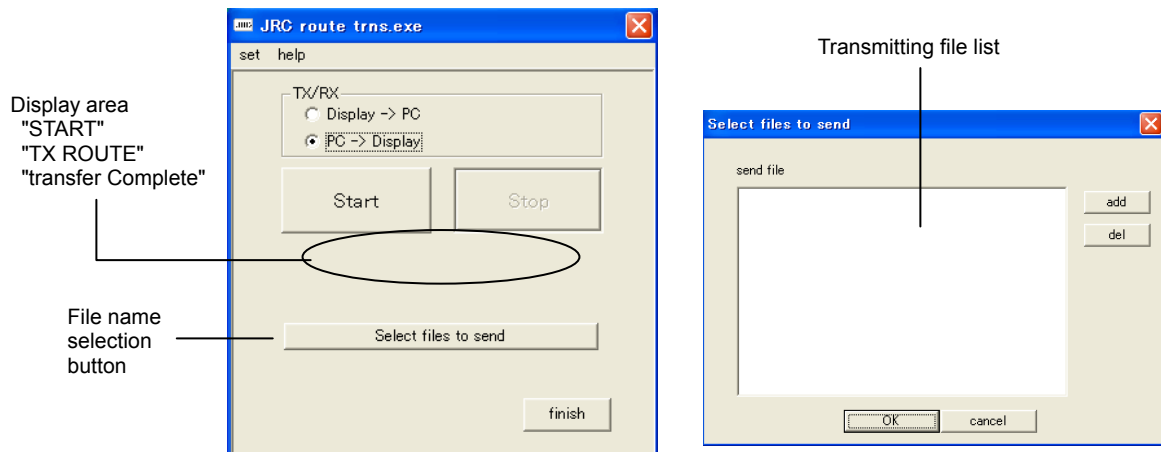

1. Select "PC=>Display" from "TX/RX".
2. Press "Select files to send".
 "add" is pressed, a transmitting file is selected and it adds to a transmitting file list.
 When a transmitting file list has an unnecessary file, select a file and press "del".
3. Press "OK"
4. Press "Start."
 It is displayed as "START" and "TX ROUTE" blinks.
 (Also in the waypoint and a track, it is displayed as "TX ROUTE".)
5. When transmission is completed, it will be displayed as "Transfer Complete".
6. Press "finish" and terminate a tool.

(4) CSV file

The example of a file created with PC is shown.

When you transmit the waypoint / route / track from PC, create a CSV file according to the example of a file.

1) Waypoint file

The example of a destination file is displayed below.

Waypoint number	Mark shape (Refer to mark list)	Comment (It is a blank when you have no comment.)	Geodetic datum of waypoint (Refer to appendix 1 Geodetic datum)					
A	B	C	D	E	F	G	H	I
WPT No	symbol(0~58)	comment	lat	lon	datum			
1	1	0	HOMEPORT	3541 S	13934 W		0	
2	2	1	A	3641 N	13935 E		0	
3	3	2	B	3541 N	14034 E		0	
4	4	3	C	3700 N	14000 E		0	
5	5	4	LONG	2041 N	12020 E		0	
6	6	5		3542 N	13933 E		0	
7	7	6		3543 N	13934 E		0	
8	8	7		3543 N	13935 E		0	
9	9	0		3541 N	13934 W		0	

Waypoint latitude longitude
 3539.48: 35 degree 39.48 minutes E/S
 13933.51: 139 degree 33.51 minutes E/W

Mark list

0	1	2	3	4	5	6	7	8	9
10	11	12	13	14	15	16	17	18	19
20	21	22	23	24	25	26	27	28	

2) Route file

The example of a route file is displayed below.

The number of waypoint in a route

The destination number in a route

Unit : [NM] fixation

Plan ship speed It is the same ship speed altogether within the same route.

Unit : [knot] fixation

Unit : [NM] fixation

0 fixation

1	A	B	C	D	E	F	G	H	I	J	K	L	M	N	O	P	Q	R
1	RTE No	WPT num	comment	WPT No	left width	right width	arv rad	plan spd	turn rate	turn rad	sal(GC/RL)	timezone	status					
2	1	2		2	1 [NM]	1 [NM]	1 [NM]	1 [knot]	0	0 [NM]	RL		0 USE					
3				4	1 [NM]	1 [NM]	1 [NM]	1 [knot]	0	0 [NM]	RL		0 USE					
4	2	3		12	2 [NM]	2 [NM]	2 [NM]	2 [knot]	0	0 [NM]	RL		0 USE					
5				2	2 [NM]	2 [NM]	2 [NM]	2 [knot]	0	0 [NM]	RL		0 NOT USE					
6				3	2 [NM]	2 [NM]	2 [NM]	2 [knot]	0	0 [NM]	RL		0 USE					
7	3	3		12	3 [NM]	3 [NM]	3 [NM]	3 [knot]	0	0 [NM]	GC		0 USE					
8				2	3 [NM]	3 [NM]	3 [NM]	3 [knot]	0	0 [NM]	GC		0 USE					
9				3	3 [NM]	3 [NM]	3 [NM]	3 [knot]	0	0 [NM]	GC		0 USE					

A comment is always a blank. It cannot enter.

Route width Within the same route, right and left are the same width altogether.

The arrival circle radius of the destination Within the same route, it is the same radius altogether.

0 fixation

Distance calculation method GC: Great Circle RL: Rhumb Lines Within the same route, it is the same calculation method altogether.

Waypoint busy condition USE: Waypoint use NOT USE: Waypoint not use

3) Track file

The example of a track file is displayed below.

In a track, only status, latitude, and longitude are effective.

Destination latitude longitude
3541.7372:35 degree 41.7372 minutes E/S
13934.7101:139 degree 34.7101 minutes E/W

0000/00/00 fixation

1	A	B	C	D	E	F	G	H	I	J	K	L	M	N	O
1	status	lat	lon	temp	depth	curA speed	curA angle	curB speed	curB angle	curC speed	curC angle	date	HMS		
2	2	3540.189 N	13936.2 E	--	--	--	--	--	--	--	--	0000/00/00	0:00:00		
3	2	3540.18 N	13936.22 E	--	--	--	--	--	--	--	--	0000/00/00	0:00:00		
4	2	3540.171 N	13936.24 E	--	--	--	--	--	--	--	--	0000/00/00	0:00:00		
5	2	3540.161 N	13936.26 E	--	--	--	--	--	--	--	--	0000/00/00	0:00:00		
6	2	3540.152 N	13936.27 E	--	--	--	--	--	--	--	--	0000/00/00	0:00:00		
7	2	3540.143 N	13936.29 E	--	--	--	--	--	--	--	--	0000/00/00	0:00:00		
8	2	3540.133 N	13936.31 E	--	--	--	--	--	--	--	--	0000/00/00	0:00:00		
9	2	3540.124 N	13936.32 E	--	--	--	--	--	--	--	--	0000/00/00	0:00:00		
10	2	3540.115 N	13936.34 E	--	--	--	--	--	--	--	--	0000/00/00	0:00:00		

Track status
1: GPS positioning
2: Beacon DGPS positioning
3: SBAS positioning





-- -- fixation

00:00:00 fixation

Section 5 Maintenance and Inspection

Proper maintenance may greatly affect the lifespan of the equipment. In order to maintain the equipment in peak state, perform the following regularly.

 WARNING	
	Do not perform internal inspections or modifications of the equipment. Inspection or modification by unauthorized personnel may result in fire, electric shock, or equipment failure. Please consult with JRC or an affiliate to perform internal inspections or repair.

 CAUTION	
	Do not use benzine, alcohol or thinner when cleaning this equipment. Doing so may result in removing the paint or changing of properties. Wipe off the grime lightly with a dry soft cloth.
	Use only the specified fuse. Failure to do so may result in fire or equipment failure.
	Use only the specified batteries. Failure to do so may result in equipment failure or malfunction.

5.1 General Maintenance and Inspection

- Always operate the equipment under standard power voltage levels (10.8 - 31.2 VDC).
- The following shows general maintenance and inspection methods using standard tools.

No.	Item	Maintenance and Inspection
1	Cleaning	Clean the panel screen, knobs, and switches with a soft cloth. There are no gears in the unit, so oil lubrication is unnecessary.
2	Parts securing	Check for loose screws, nuts, and connectors, and connect securely any that have loosened.

- Perform inspection of the displayed items when the equipment is functioning normally. Compare operating results to the normal operation values in order to detect problems quickly.

5.2 Alerts

Refer to "4.15.9.3 Displaying an alert" and check if any alert is given or not. If it is, check the details referring to the list shown below.

Alert List

Message Number	Message Contents	Causes	Category	Priority
2	SOG	Speed alert occurs	B	W
10	TRIP	Trip alert occurs	B	W
12	Arrival Wpt	Arrival at waypoint	A	W
13	Anchor Out	Anchor alert occurs	A	A
14	Xtd	XTD alert occurs	A	A
16	HDOP Over	HDOP value has exceeded setting level	B	C
25	GPS Antenna Open	GPS Antenna Open (Sensor)	B	W
25	GPS Antenna Short	GPS Antenna Short (Sensor)	B	W
26	GPS ROM Error	Memory Error (GPS core of Sensor)	B	W
27	GPS RAM Error	Memory Error (GPS core of Sensor)	B	W
28	GPS RTC Error	RTC (Real Time Clock) Error (GPS core of Sensor)	B	W
41	Controller ROM Error	Memory Error (Processing Unit of Sensor)	B	W
42	Controller RAM Error	Memory Error (Processing Unit of Sensor)	B	W
43	Controller FPGA Error	FPGA Error (Processing Unit of Sensor)	B	W
44	Controller BACKUP Error	Data Backup Error (Processing Unit of Sensor)	B	W
45	Flash ROM Access Error	Flash ROM Deletion, Write Error (ROM[1])	B	W
46	Flash ROM2 Access Error	Flash ROM Deletion, Write Error (ROM[2])	B	W
47	SEEPROM Access Error	SEEPROM Deletion, Write Error	B	W
48	RAM Access Error	RAM Read, Write Error	B	W
49	Serial 0 Error	Serial Port Error (SIO[0])	B	W
50	Serial 1 Error	Serial Port Error (SIO[1])	B	W
51	Serial 2 Error	Serial Port Error (SIO[2])	B	W
52	Serial 3 Error	Serial Port Error (SIO[3])	B	W
53	Serial 6 Error	Serial Port Error (SIO[6])	B	W
103	No Fix	No1 GPS No Fix	B	W
106	No FIX	No2 GPS No FIX	B	W
-	No Sensor Data	Sensor periodic input not possible (No data)	-	-
-	Sensor Data Invalid	Sensor information unobtainable (Position, Time, Course, etc.)	-	-

5.3 Troubleshooting

5.3.1 Troubleshooting

WARNING



Do not perform internal inspections or modifications of the equipment. Inspection or modification by unauthorized personnel may result in fire, electric shock, or equipment failure. Please consult with JRC or an affiliate to perform internal inspections or repair.

The following is reference information concerning identification of problems.

Symptom	Possible Causes	Troubleshooting Measures
The power does not turn on when the power switch is pressed.	Power is not being supplied by the ship junction box.	Check whether the cabling from the junction box is normal.
	Power is not being supplied by the power supply equipment (option).	Check whether the power supply unit cabling is normal.
	The fuse connected to the power cable has blown.	If there are no problems in the cabling, replace the fuse.
	The power supply equipment (option) fuse has blown.	If there are no problems in the cabling, replace the fuse.
	The display unit switch is broken.	Consult with JRC or our agents.
The LCD display does not display anything.	The LCD display is broken.	Consult with JRC or our agents.
The display does not light up.		
The alert sound is not generated.	The buzzer is broken.	Consult with JRC or our agents.
	The alert sound is turned off.	Refer to 4.12.8
The click does not sound.	The key press sound is turned off.	Refer to 4.9.3
There is no reception (from sensor).	The sensor connection cable is disconnected.	Check the connection cable.
	The sensor is broken.	Consult with JRC or our agents.
There is no transmission (to external devices).	Output settings have not been configured.	Refer to 4.15.5.1
	The configured channel is incorrect.	Refer to 6.3.1
	The DISP-DPU or POWER SUPPLY UNIT is broken.	Consult with JRC or our agents.
The Dimmer are not interlocked.	The baud rate is different.	Refer to 4.15.4.4
	The dimmer group is different.	Refer to 4.15.4.3
	The dimmer is different.	Refer to 4.15.3
	The cable is disconnected.	Check the connection.
Data is not shared.	The baud rate is different.	Refer to 4.15.4.4
	Output sentence is not selected.	Refer to 4.15.4.4
	The cable is disconnected.	Check the connection.

5.3.2 Repair Unit

Repair units and their models are shown below.

No.	Name	Model	Notes
1	DISP-DSP	CMJ-562	NWZ-4610 Display Unit
2	LCD UNIT	CCN-423	NWZ-4610 Display Unit
3	POWER SUPPLY UNIT	CMP-490	NWZ-4610 Display Unit
4	Beacon Antenna	CAW-1	For JLR-4341 DGPS Sensor
5	Beacon Controller	CMA-920	For JLR-4341 DGPS Sensor

Fuse

No.	Name	Model	Notes
1	Fuse	MF60NR 250V 1	NWZ-4610 Display Unit 1A Fuse

If Beacon Controller or Sensor is replaced, perform master reset for sensor only.

Mechanical Parts

No.	Name	Code	Notes
1	FRONT PANEL KIT	MPBC47673	FRONT PANEL PRODUCT NAMEPLATE

5.3.3 Regular Replacement Parts

Parts that should be regularly replaced are shown below.

Contact JRC or one of our agents to order.

Replace the radome and packing when replacing the lithium batteries.

No.	Name	Model	Life	Notes
1	LCD UNIT (Inside display unit)	CCN-423	40000 hours	Approximately 5 years of continuous use
2	Lithium Battery (Inside JLR-4341 DGPS Sensor)	CR2354-1V C	Approximately 5 years	Reception is possible even without battery power. (It will take 30 to 60 seconds longer to fix the position)
3	Radome Kit (JLR-4341 DGPS Sensor Radome and Packing)	MPAE30534	Battery replacement	Opening the radome decreases waterproofing effectiveness, so replace the radome and packing as well as when performing battery replacement.

Section 6 Installation

WARNING



To connect the sensor other than JLR-4341/4340, set the supply voltage of the display unit to 12 VDC (10.8 to 15.6 VDC) for use. Failure to do so causes fire, electric shock or failure.

CAUTION



Please consult with JRC or our agents to perform installation. Installation by unauthorized personnel may result in malfunction.



Do not use or leave the equipment at places where it is exposed to direct sunlight or to hot air for an extensive period of time or the temperature becomes 55 degrees centigrade or higher . Doing so sometimes causes fire or failure.



Do not put the equipment on an unstable place such as wobbly base or tilted area. Doing so sometimes causes the equipment to drop or fall, resulting in injury and failure.



Do not put the equipment in the cabinet or cover it with the cardboard. Doing so sometimes causes the equipment to be filled with heat, resulting in fire and failure.



When this unit is suddenly moved from a cool place to a warm place, dew condensation water may form on the inside windows, and the liquid crystal part can become visually difficult. In this case, leave the unit for a while until becoming dry condition. Then operate the unit.

6.1 GPS Sensor Installation

6.1.1 Selecting the Position for Installation

WARNING



To connect the sensor other than JLR-4341/4340, set the supply voltage of the display unit to 12 VDC (10.8 to 15.6 VDC) for use. Failure to do so causes fire, electric shock or failure.

CAUTION



When connecting the cable attached to the sensor, do not bend it acutely, twist it, or impart excessive force. Doing so sometimes causes cracks or damage to the coating, resulting in fire or electric shock.



Do not install the sensor where there is excessive vibration. Vibration may cause sensor failure.



Do not paint the sensor. Doing so may result in reception problems.



Do not install the sensor where temperature exceeds 55 °C and there is covered with exhaust gas from funnel. Doing so may result in equipment failure or malfunction.



The junction box rubber gaskets (25 f Gland side) fit ϕ 10mm - 20mm cables.



Install the sensor where there are no obstacles, in order to ensure that GPS signals can be directly received from satellites without interference or reflection of signals from surrounding objects.

Whenever possible, select a place with the following characteristics.

1. An open space, which allows uniform reception of satellite signals.
2. Far away from any high power transmission antennas.
3. Outside radar beams.
4. Away from the INMARSAT antenna by at least 5 meters and outside the INMARSAT beam.
5. Away from the antenna of a VHF transmitter and a direction finder by at least 3 meters.
6. Away from a Magnetic Compass by at least 1 meters.
7. Away from amateur radio antennas by at least 3 meters.

If it is difficult to find an ideal site, select a place temporarily and install the equipment. Conduct a test to make sure that the proper performance can be obtained and then fix the equipment in position. If it is installed at an improper place, reception accuracy may be impaired.

6.1.2 Sensor Installation Procedure

The sensor base contains 1 inch-14UNS-2B screw holes. It can be attached to poles with cut male screws, or off-the-shelf adapters.

- (1) When performing attachment, always hold and turn the sensor base. Holding and turning the radome may result in a large amount of force applied at the junction of the base and the radome, resulting in damage to the sensor. When performing attachment, do not use adhesive for screw or other adhesive for screw part. Adhesive component may attack to the radome, resulting in cracks. The diagram shows the JLR-4341, but these instructions apply equally to the JLR-4340 as well.

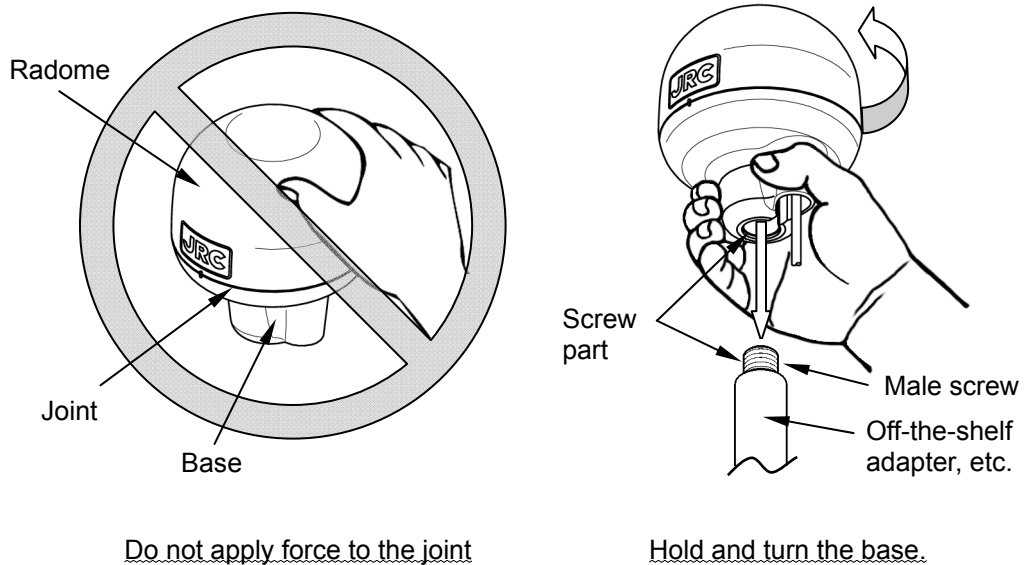

- (2) Secure the sensor cable in position with a clamp band as shown below to protect it against damage due to vibration.

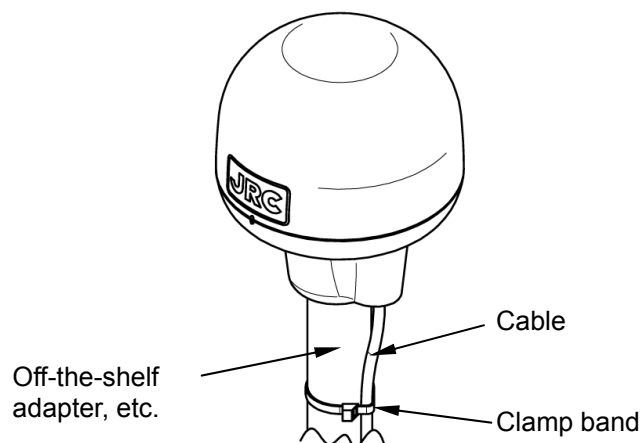

- (3) When connecting an extension cable to the DGPS sensor, always seal with self-bonding tape in order to waterproof the connector, and wrap this section with vinyl tape to protect it. Waterproof treatment points Refer to "Attention : Protection of connector against water" within "6.4.3 SENSOR/DATA2 Connector".

6.1.3 Installation of the Sensor on the Mast

Use a screw adapter (optional component or equivalent) to connect the sensor to the mast. The diagram shows the JLR-4341, but these instructions apply equally to the JLR-4340 as well.

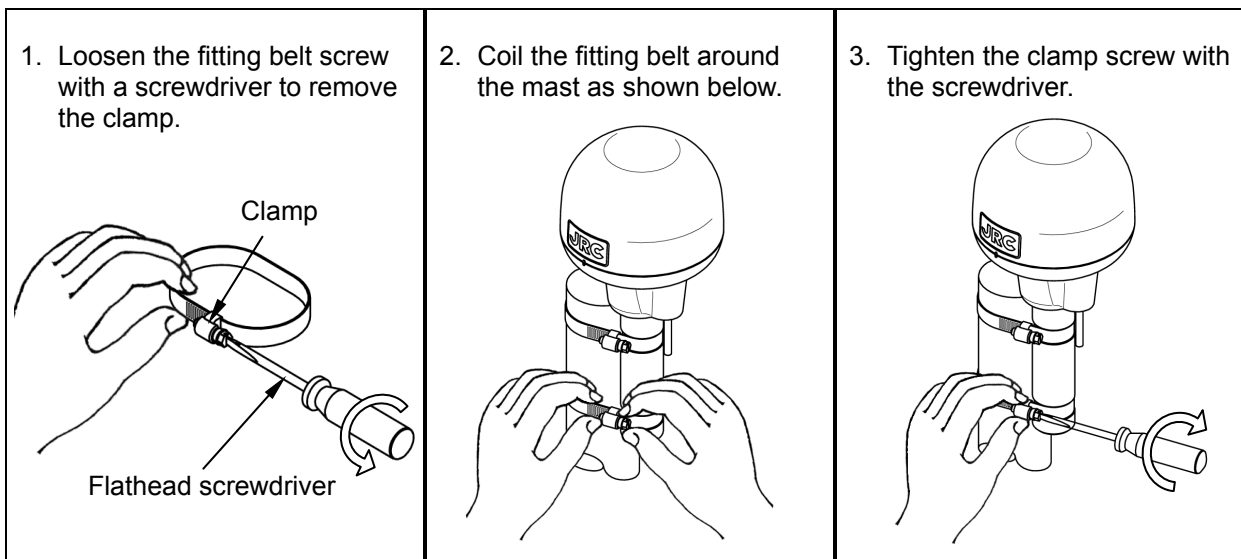
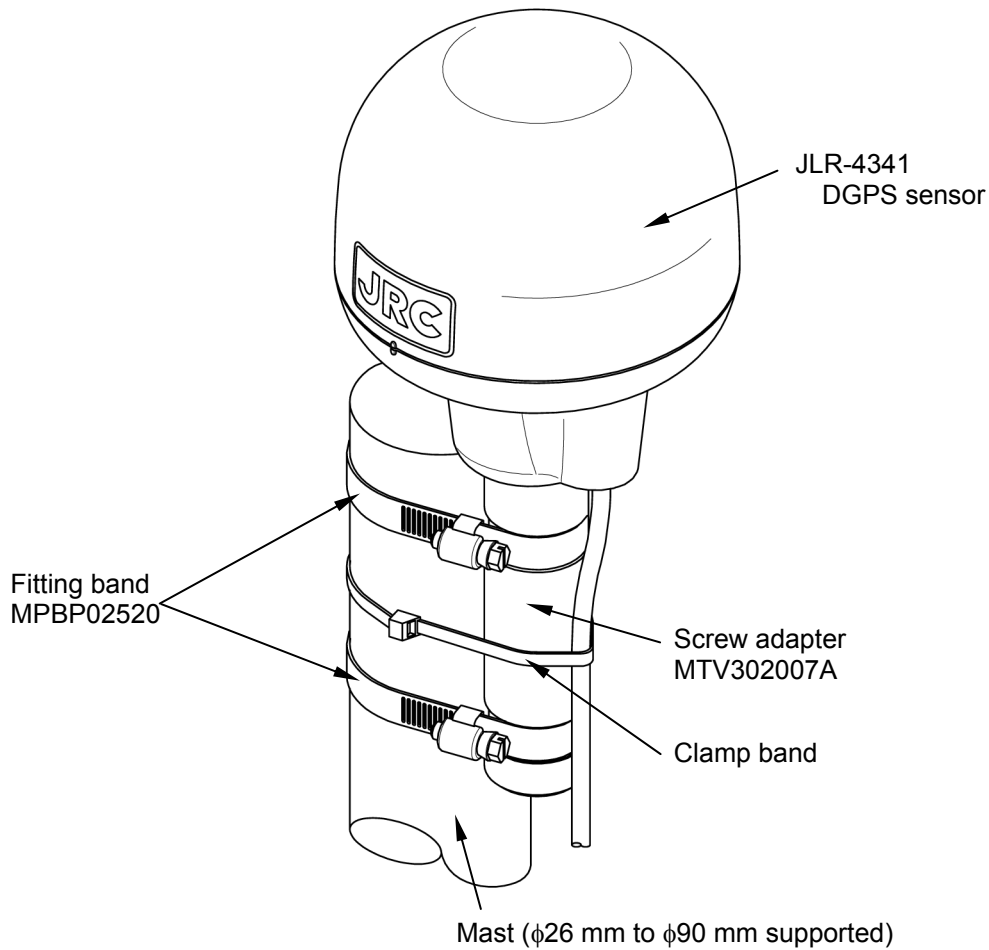

How to install the sensor on the mast

6.1.4 Installation of the Sensor to Pass a Cable through a Pole

It is possible to pass a cable through a pole, when DGPS sensor attached to poles with cut male screws. (1 inch-14 UNS-2A). In this case, cable guard rubber (accessory) is used.

- (1) The cable is installed as following figure. Do not bend the cable acutely. Doing so may result in damage to the cable.

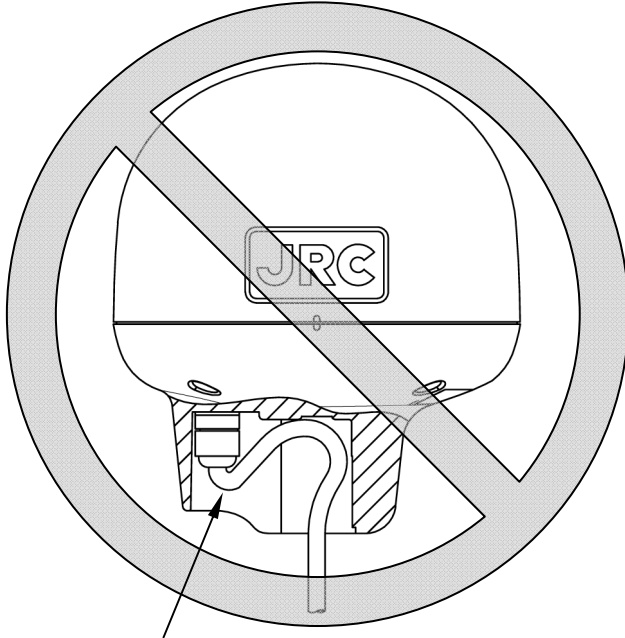

Do not bend it acutely.

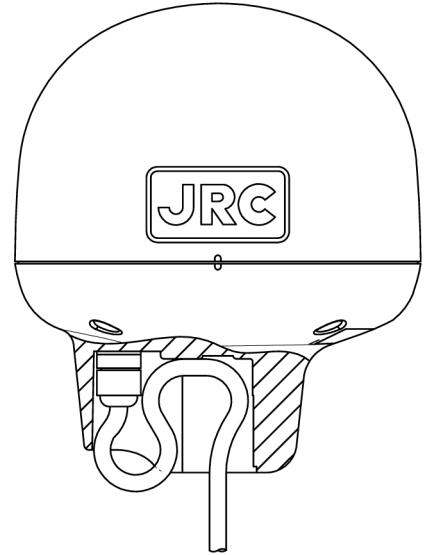

Cable installation figure

- (2) Push the accessory cable guard rubber all the way in the hole as shown below.

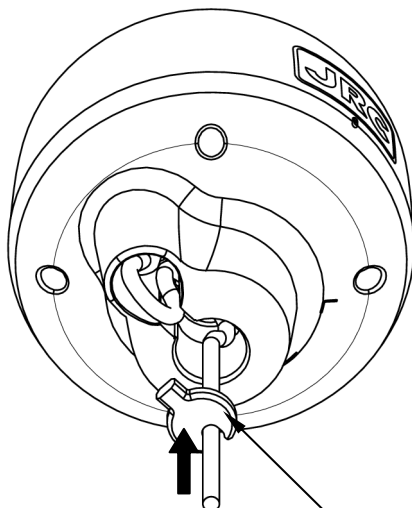

Cable guard rubber
(accessory)

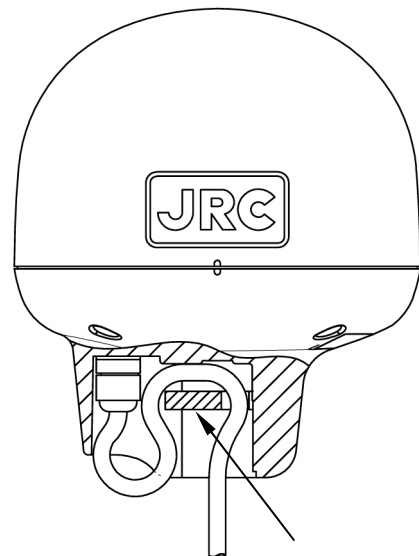

Push all the way
in.

- (3) Attach the sensor to the poles with cut male screw. Be sure to deburr the pole end face (see below).

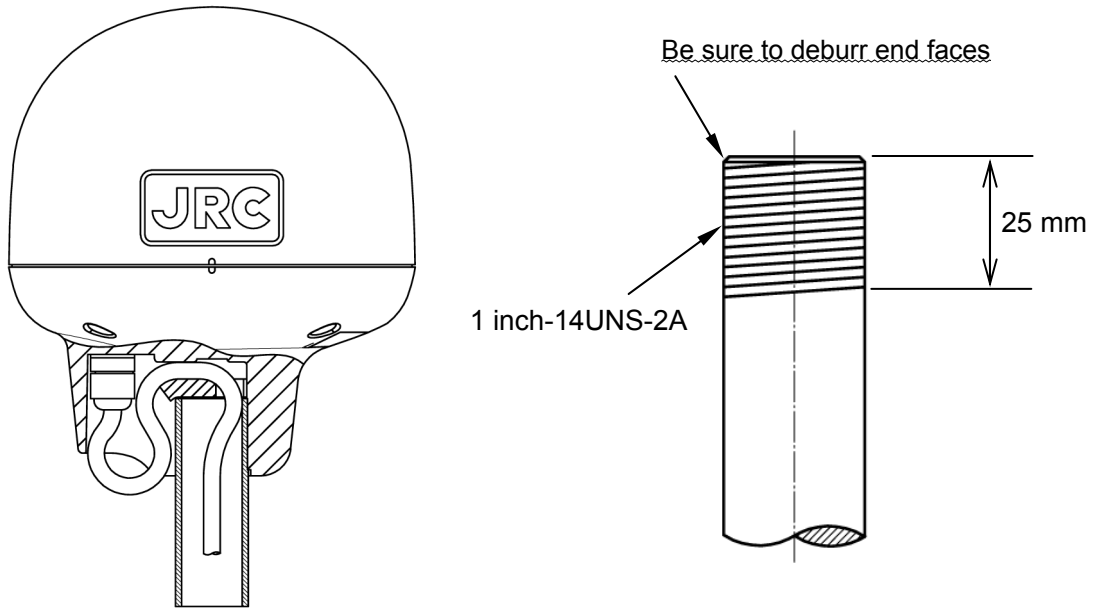

Example of cutting pole

- (4) When performing attachment, always hold and turn the sensor base. Holding and turning the radome may result in a large amount of force applied at the junction of the base and the radome, resulting in damage to the sensor. When performing attachment, do not use adhesive for screw or other adhesive for screw part. Adhesive component may attack to the radome, resulting in cracks.

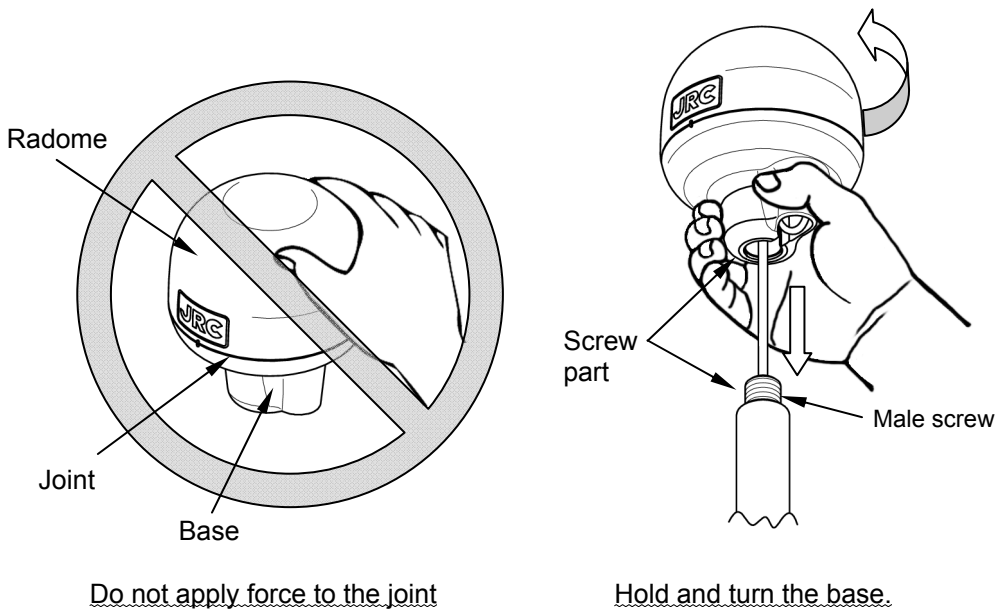

6.2 Affixing Display Unit Nameplate Labels

6.2.1 Affixing Product Nameplate

Peel the label of the equipment to be used from the accessory product nameplate, and affix it to the center of the front panel.

When you use the old receiver (except JLR-4341 / 4340 receiver), use the seal of "NWZ-4610 GPS."

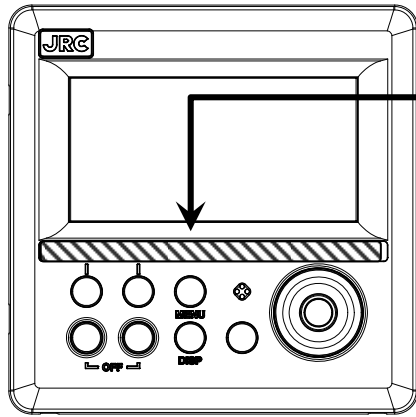

Display Unit Front

製品銘板 Product Name Plate		Model
使用用途に応じて、フロントパネル中央部に貼り付けて下さい。 Put this label on the center of the front panel as usage.		
MOB/EVENT	GOTO	NWZ-4610 GPS (G)
MOB/EVENT	GOTO	JLR-7600 GPS (G)
MOB/EVENT	GOTO	JLR-7900 GPS (G)
USER	MODE	NWZ-4610 MULTI INFO DISPLAY (☆)
TRIP RESET	UNIT	JLN-205MK2 SPEED LOG (L)
ディジーチェーンにて使用するとき、フロントパネル上部のJRCマークの右側に、各機器の接続順に貼り付けて下さい。 Put this connected number label to the each equipment on the right of the "JRC" of the upper of the front panel for use as daisy chain.		
No.1	No.2	No.3 (☆)

Product Nameplate (Accessory)

6.2.2 Affixing Model Identification Plate

Peel the label of the equipment to be used from the accessory model identification plate, and affix it over the upper left blank part of the unit nameplate at the center of the rear case.

When you use the old receiver (except JLR-4341 / 4340 receiver), use the seal of "GPS NAVIGATOR."

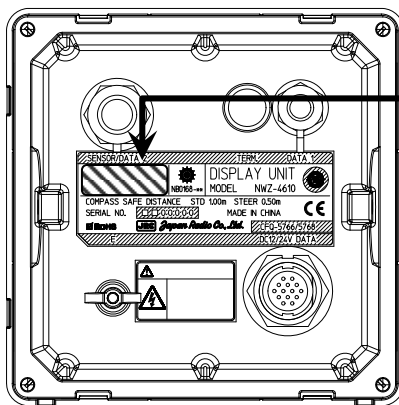

Display Unit Rear

モデル銘板 Model Identification Plate		Model
使用用途に応じて、本体銘板の左上の空欄に重ね貼りして下さい。 Put this label on the blank space of the left upside of the main label as usage.		
Old sensor	GPS NAVIGATOR	(G)
JLR-7600	GPS NAVIGATOR MODEL JLR-7600	(G)
JLR-7900	GPS NAVIGATOR MODEL JLR-7900	(G)
	MULTI INFORMATION DISPLAY	(☆)
	DOPPLER LOG	(L)

Model Identification Plate (Accessory)

After model name plate attachment (example: JLR-7600)

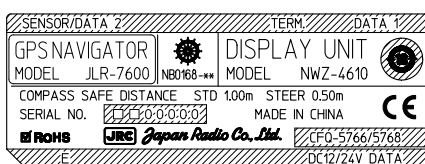

6.3 Display Unit Installation

6.3.1 Selecting the Position for Installation



WARNING



Install this display at least 1 m away from any magnetic compasses. Installation near a magnetic compass may interfere with the magnetic compass, resulting in an accident.



Do not use this display at the voltage other than its rated voltage. Doing so results in fire, electric shock or failure.



CAUTION



Use the indicated screws when installing the display unit to a stable wooden surface. Failure to do so may result in the display unit falling over, causing injury or property damage.



During installation, be sure to connect the earth plate and earth cable to the earth terminal. Failure to do so may cause electric shock in case of failure and electric leak.



Do not use or leave the equipment at places where it is exposed to direct sunlight or to hot air for an extensive period of time or the temperature becomes 55 °C or higher. Doing so sometimes causes fire or failure.



Do not put the equipment on an unstable place such as wobbly base or tilted area. Doing so may cause the equipment to drop or fall, resulting in injury and failure.



Do not put the equipment in the cabinet or cover it with the cardboard. Doing so may cause the equipment to be filled with heat, resulting in fire and failure.



Use the proper power cable, signal cable, and earth cable. Failure to do so may cause this unit to damage other equipment and vice versa.

6.3.2 Mounting the display unit using a rack

Use the following procedure.

- (1) Fix the desktop rack at the required installation position by using the mounting screws ($\phi 4\sim 6$ screw or wood screw, $L\geq 15\text{mm}$, provided by the shipyard).
- (2) Insert the front panel into the main unit.
- (3) Attach the rotational washer on the side of the main unit.
- (4) Attach the rotational washer on the side of the desktop rack.
- (5) Assemble the main unit on the desktop rack, insert the knob metal washer between the desktop rack and the knob bolt, and fix the main unit by tightening the knob bolts.

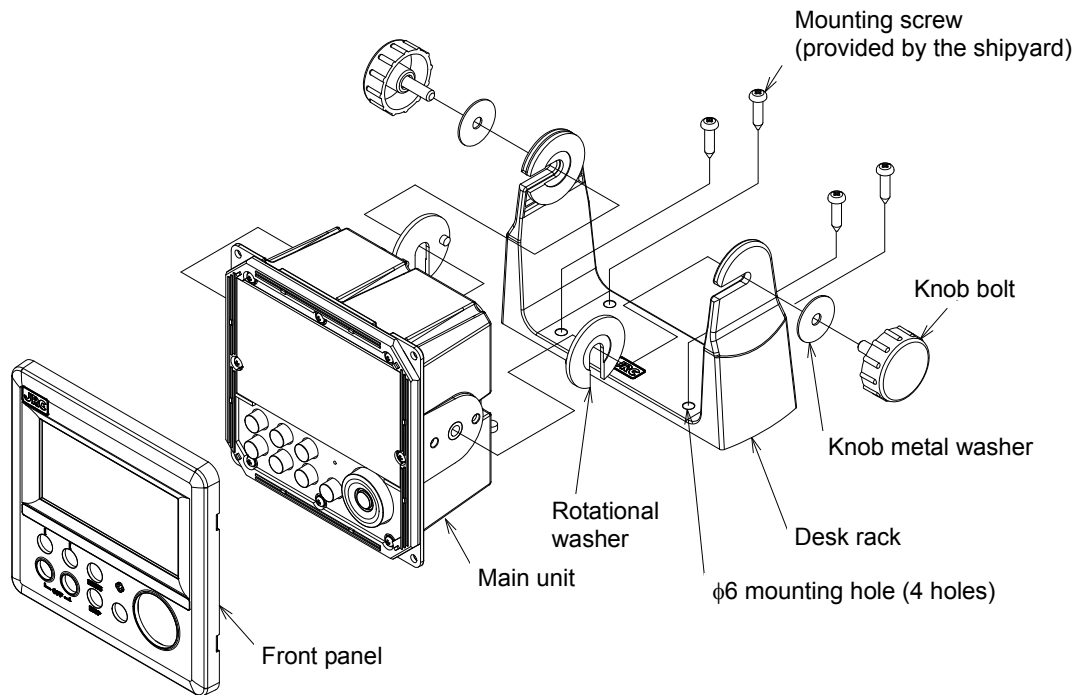

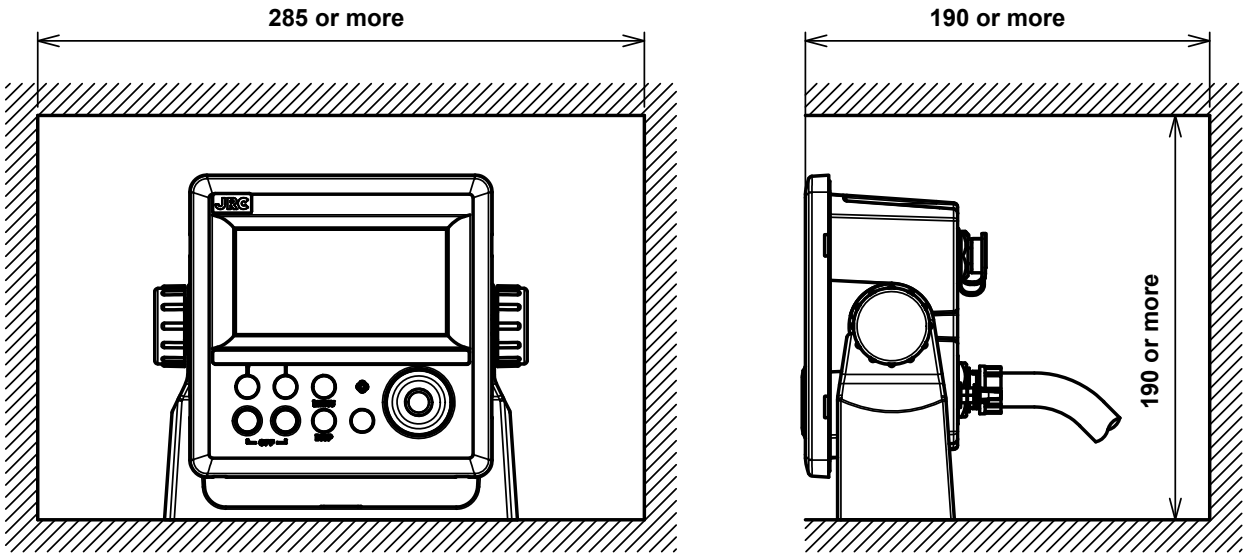

Required installation space

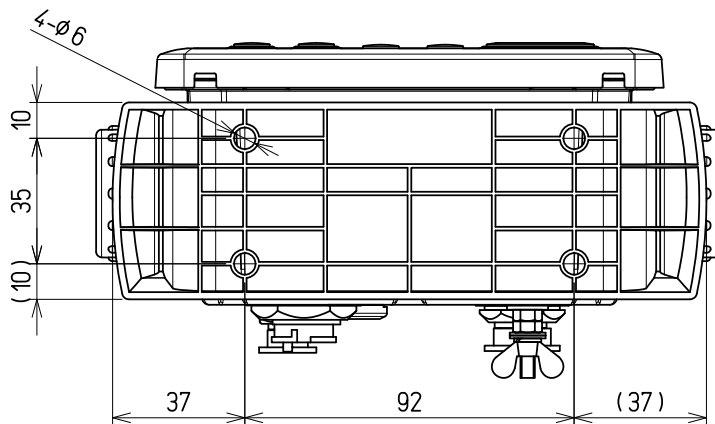

Mount (bottom)

(Unit: mm)

6.3.3 Mounting using a flash mount

Use the following procedure.

See the diagram below for the mounting space and mounting holes.

- (1) Insert the main unit in the installation location.
- (2) Fix the main unit using screws ($\phi 4$ screw or wood screw, $L \geq 10\text{mm}$, provided by the shipyard).
The sizes of the heads of the screws that are used are restricted as follows including the washers.
 - Diameter: Up to $\phi 8$ mm
 - Height: Up to 4.5 mm
- (3) Insert the front panel into the main unit

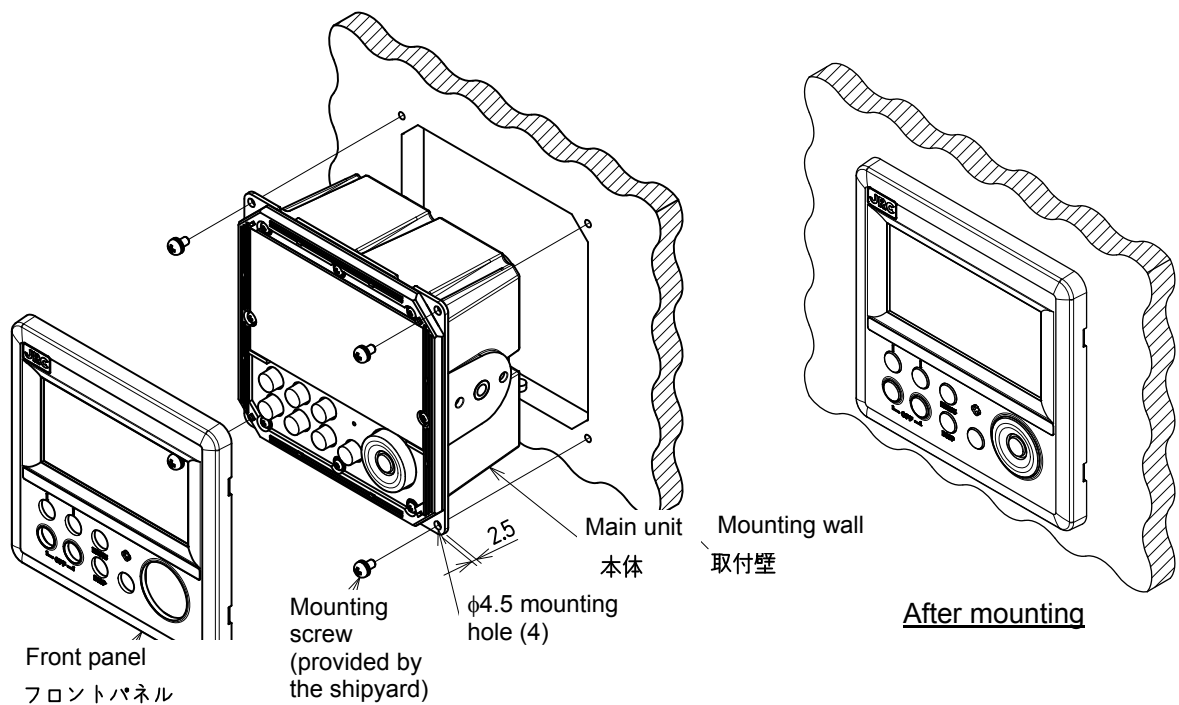

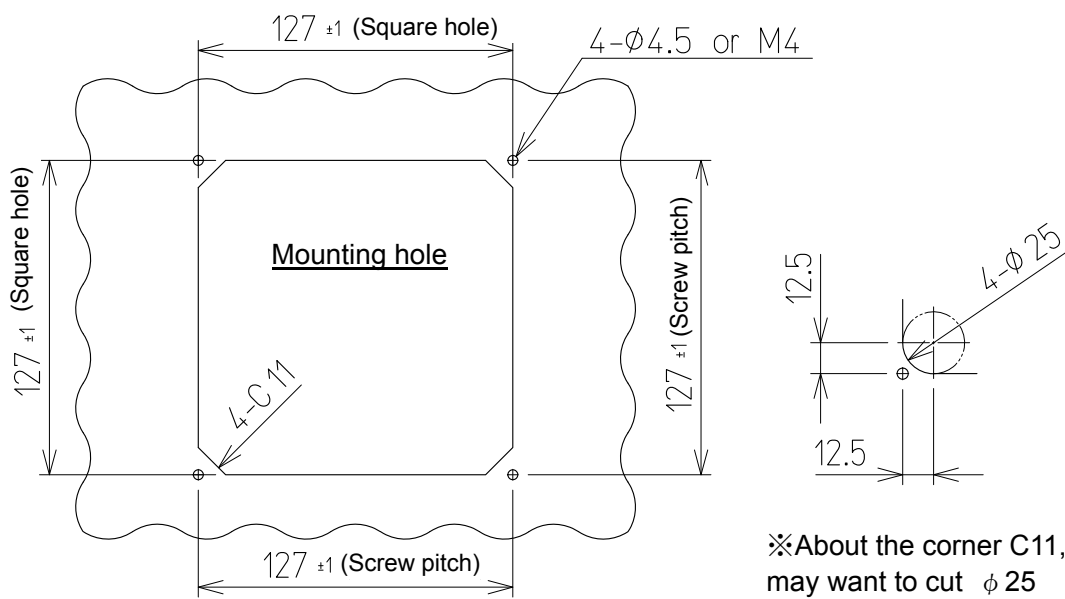
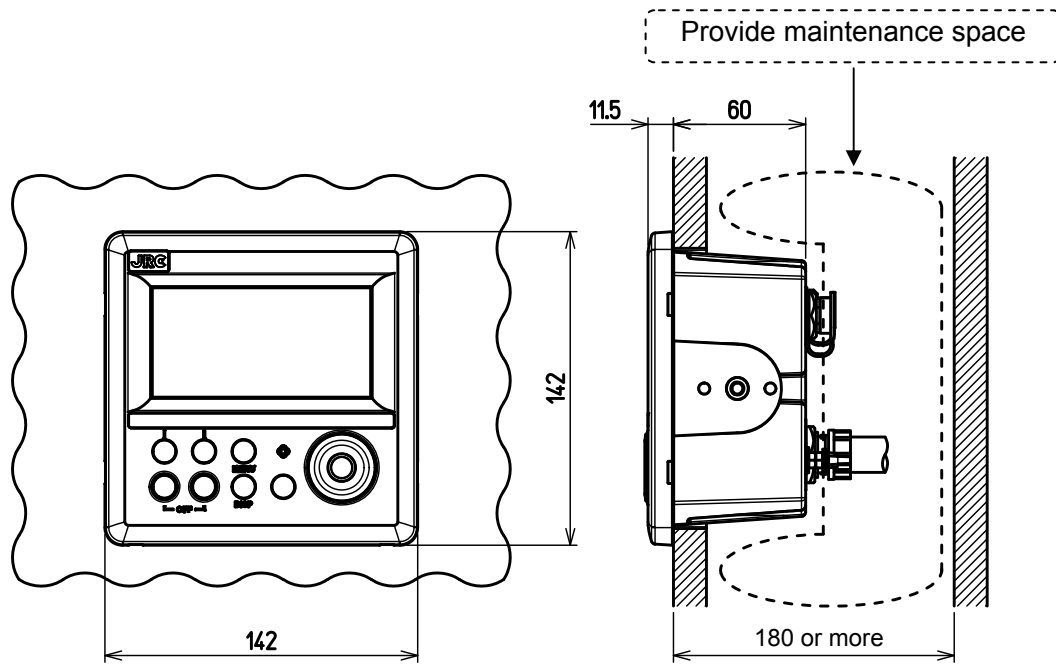

(Unit: mm)

6.3.4 Removing the display unit by flash mounting

Use the following procedure to remove the display unit.

- (1) Insert a hexagonal wrench into the holes (2) at the bottom of the front panel.
- (2) Remove the front panel by pressing down the hexagonal wrench.

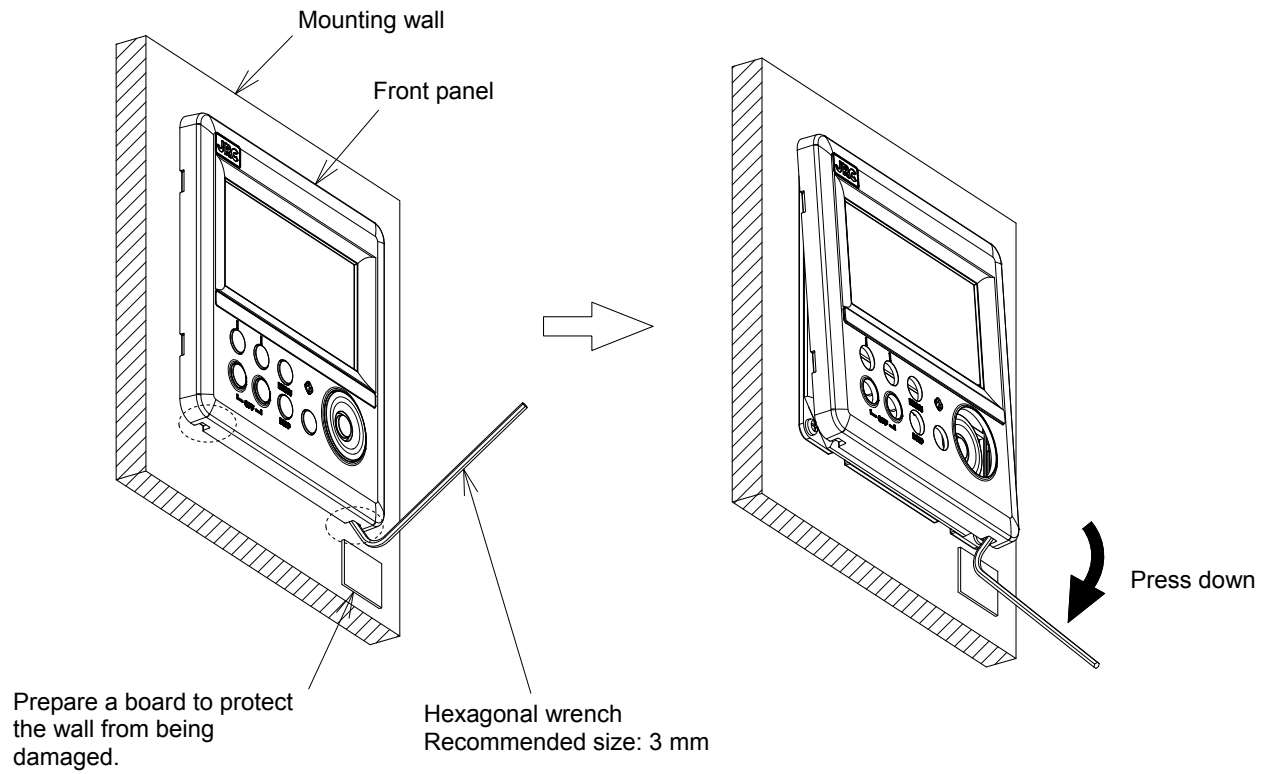

6.4 Cable Connection

- Unit (Rear Connector)

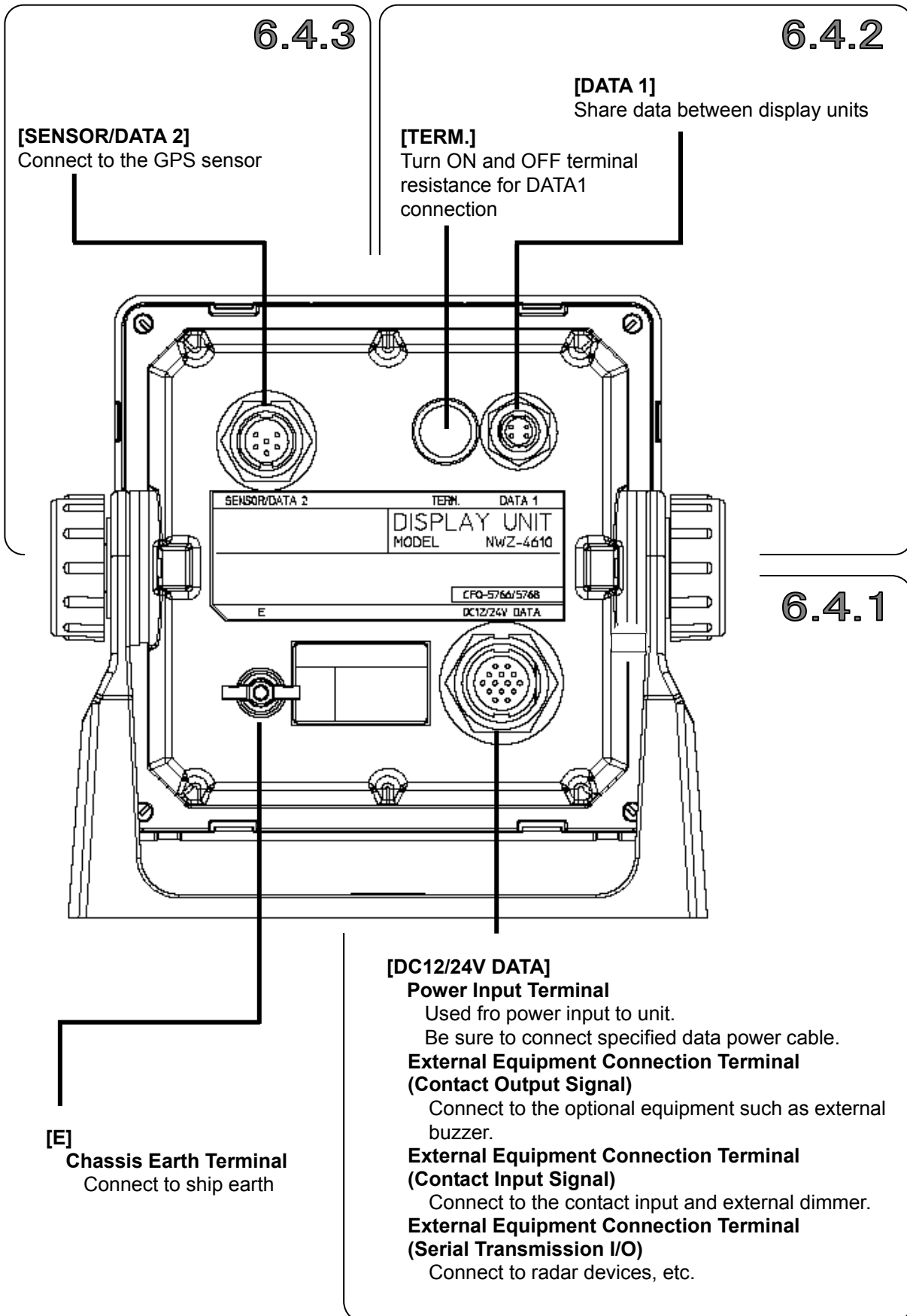

6.4.1 DC12/24V DATA Connector

In this display, the voltage supplied to the display is supplied to a receiver as it is. When you use receivers except JLR-4341/JLR-4340, set the power supply of a display to DC12V. Supply of 24V will damage a receiver.

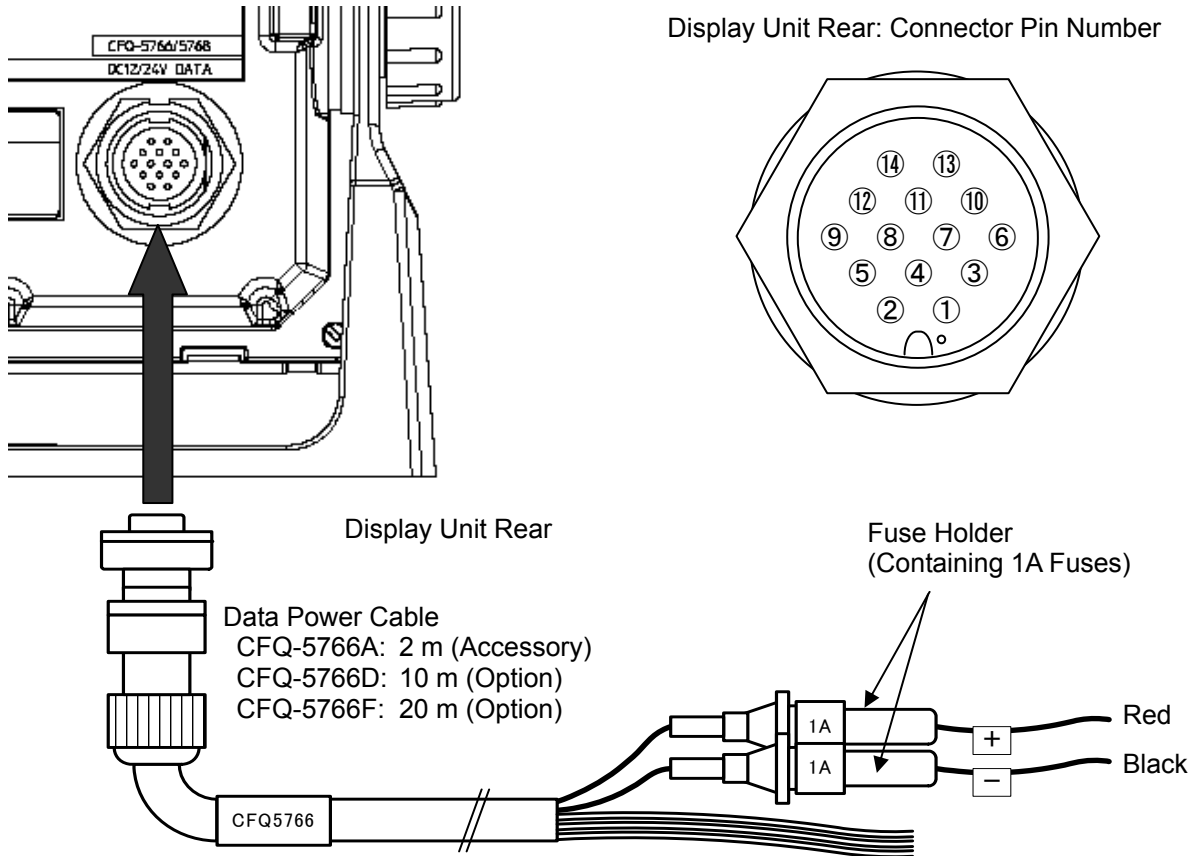

Terminal Number (CFQ-5766)	Name	Explanation
1	Red	DC12/24V
2	Black	
3	Orange	Contact Output
4	Yellow	
5	Green	
6	Blue	Contact Input Analog Input
7	Purple	
8	Gray	Serial Transmission DATA I/O1
9	White	
10	Pink	Serial Transmission DATA I/O2
11	Sky blue	
12	Bright green	Serial Transmission DATA I/O3
13	Brown	
14	Black (Shield)	Chassis Earth

[Input/Output Condition for Serial Transmission]

The data power cable (CFQ-5766) has three serial transmission channels.

The input/output settings for DATA I/O "1" and "2" are linked to each other. As listed below, four connections and settings can be made.

For the input/output settings for channels, see "4.15.5 Setting a serial port".

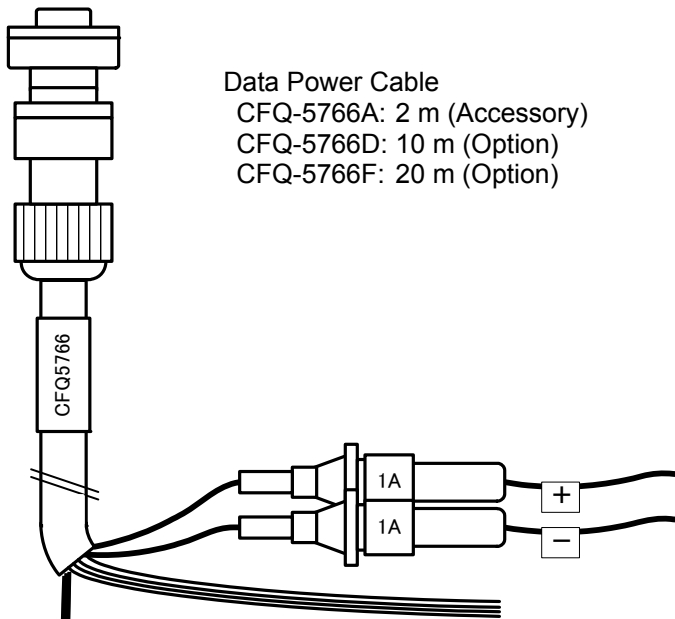

Data Power Cable
 CFQ-5766A: 2 m (Accessory)
 CFQ-5766D: 10 m (Option)
 CFQ-5766F: 20 m (Option)

Terminal Number (CFQ-5766)		Name		Input/Output Condition			
				3ch Input	2ch Input 1ch Output	1ch Input 2ch Output	3ch Output
8	Gray	Serial Transmission DATA I/O1	SD0-A	Input	Input	Output	Output
9	White		SD0-B				
10	Pink	Serial Transmission DATA I/O2	SD3-A	Input	Output	Input	Output
11	Sky blue		SD3-B				
12	Bright green	Serial Transmission DATA I/O3	SD6-A	Input	Output	Input	Output
13	Brown		SD6-B				

[Input/Output Circuit]

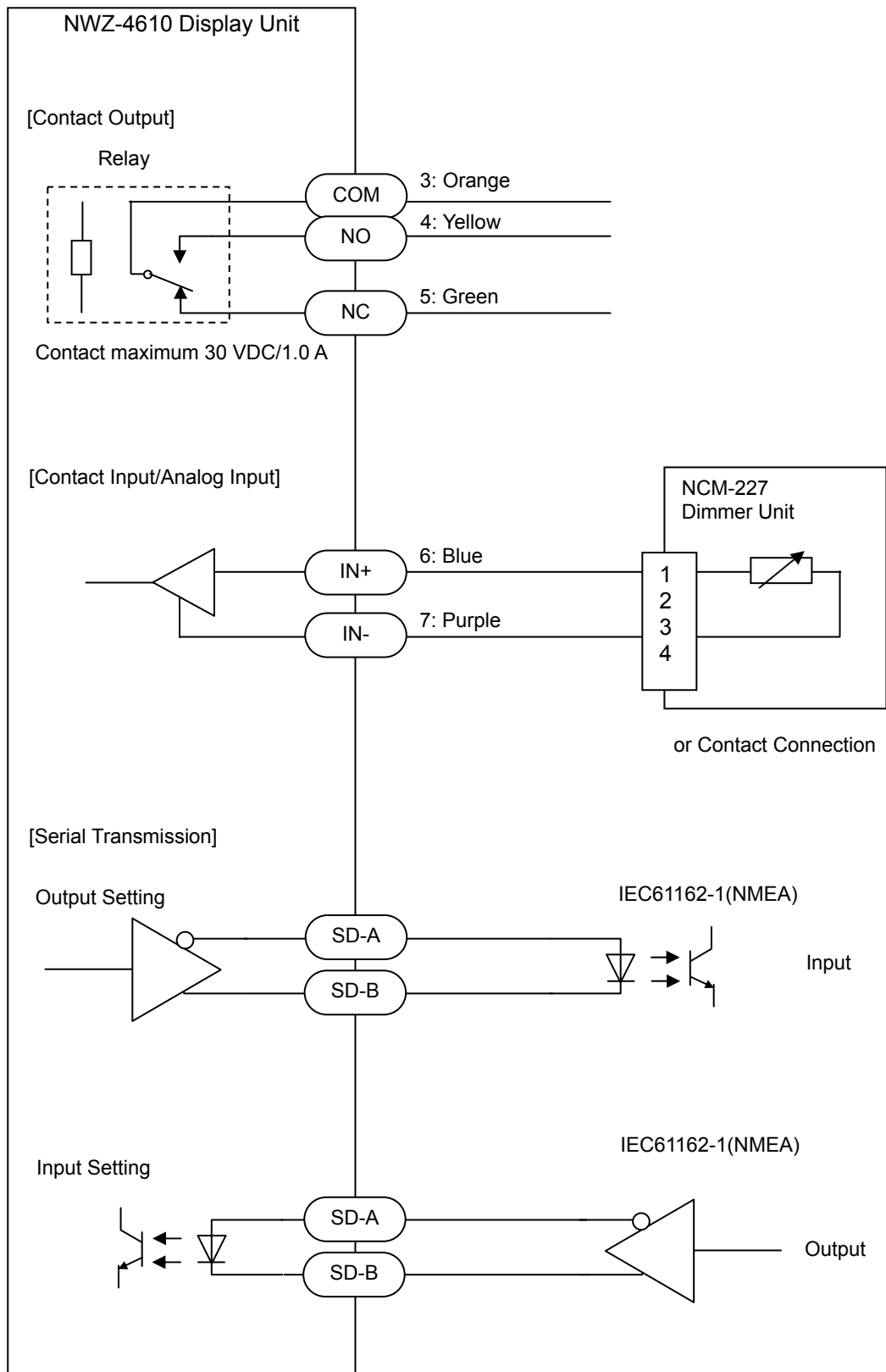

6.4.2 DATA1 Connector

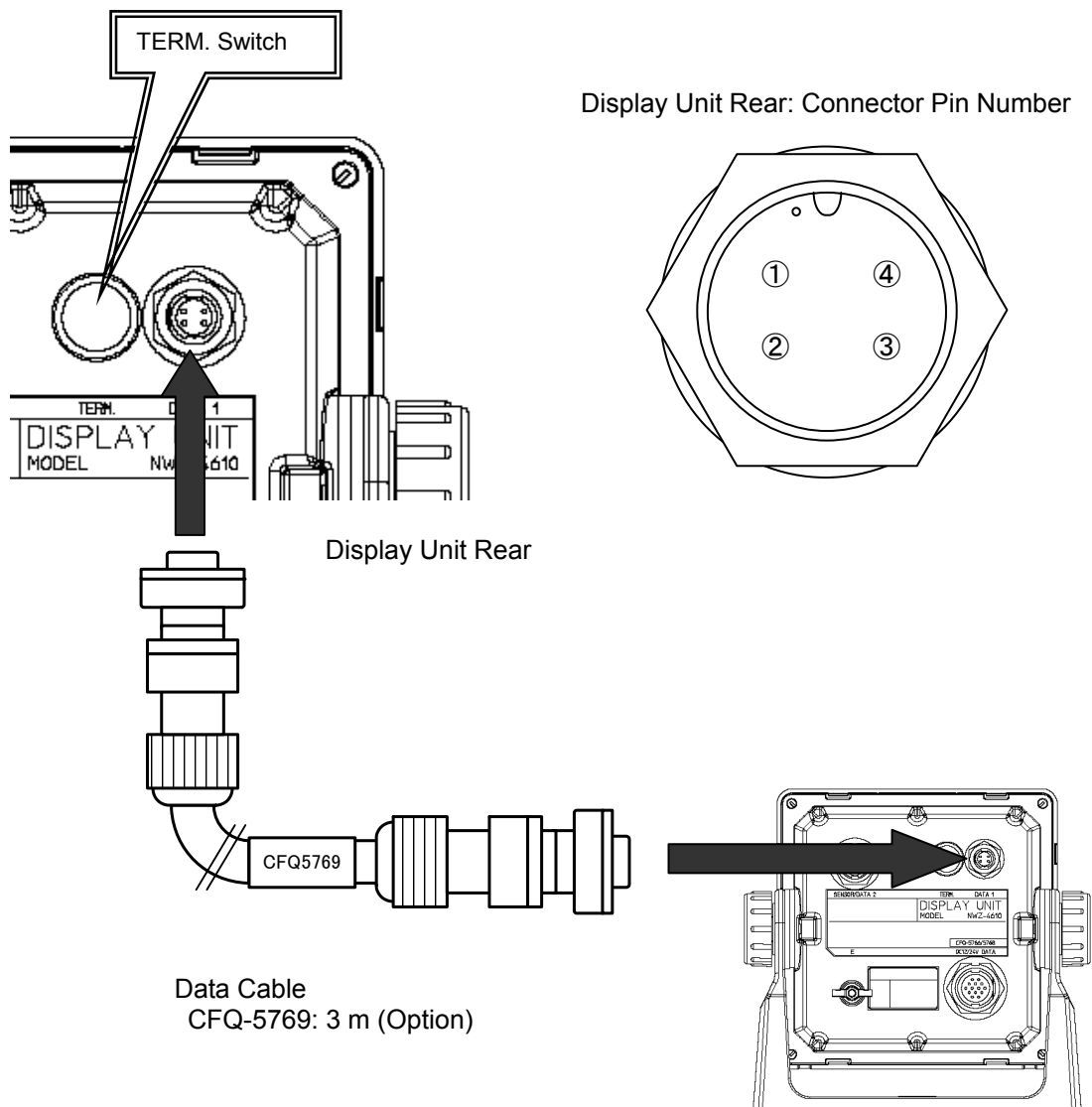

Terminal Number (CFQ-5769)		Name		Explanation
1	Brown	Serial Transmission RS-485	SD1-A	Connect to the display unit for serial transmission
2	Red		SD1-B	
3	Green		SD1-C	
4	Shield	Chassis Earth	E	Chassis earth

[TERM. Switch]

When this terminal is connected, move the TERM. switch (terminator) to ON.

To connect multiple units, move the TERM. switches on both ends of the display unit to ON.

When the rubber cap is removed, the switch appears.

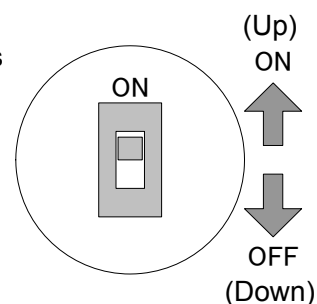

[T-SHAPED CONNECTOR]

This T-SHAPED CONNECTOR can be used to extend cables and connect multiple units (up to 10 units).

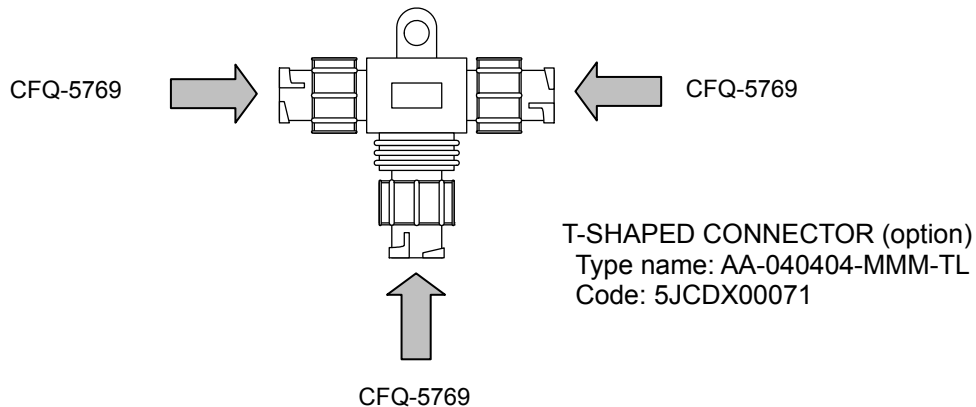

[To Extend the Cable]

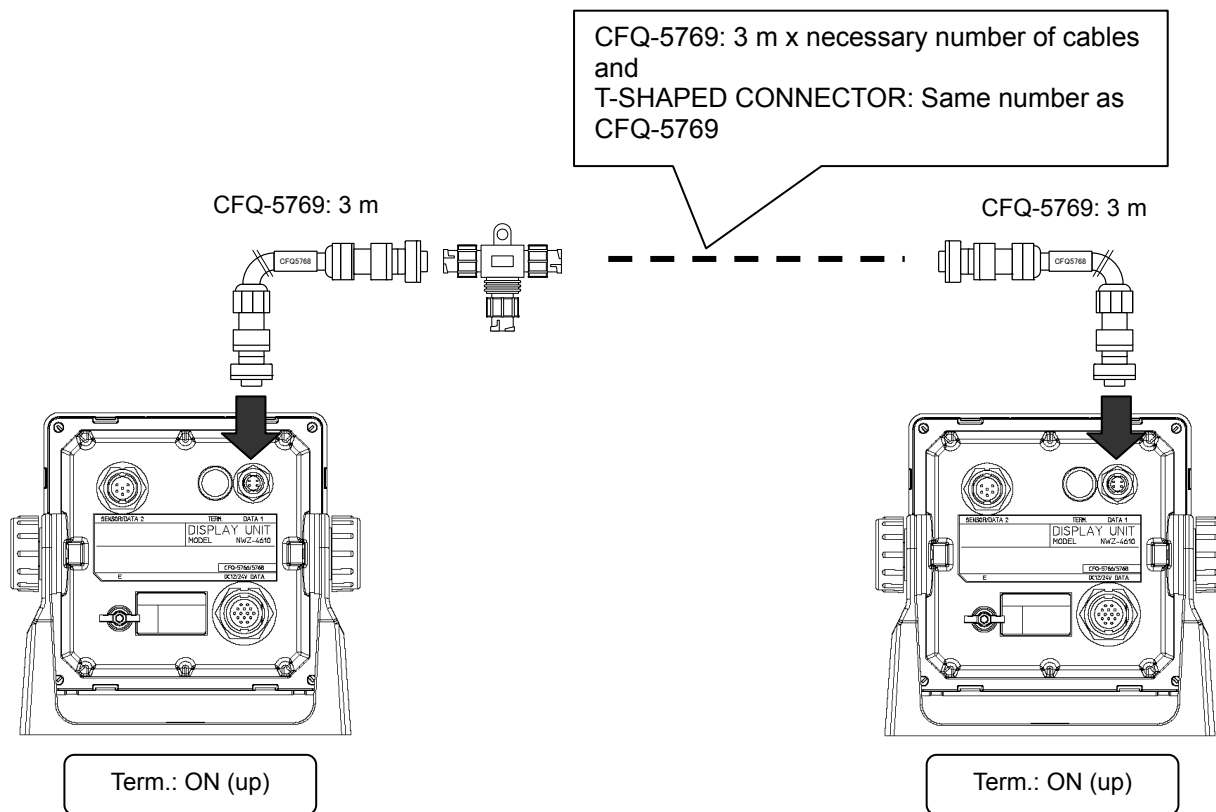

[To Connect Multiple Units]

- Up to 10 units can be connected.

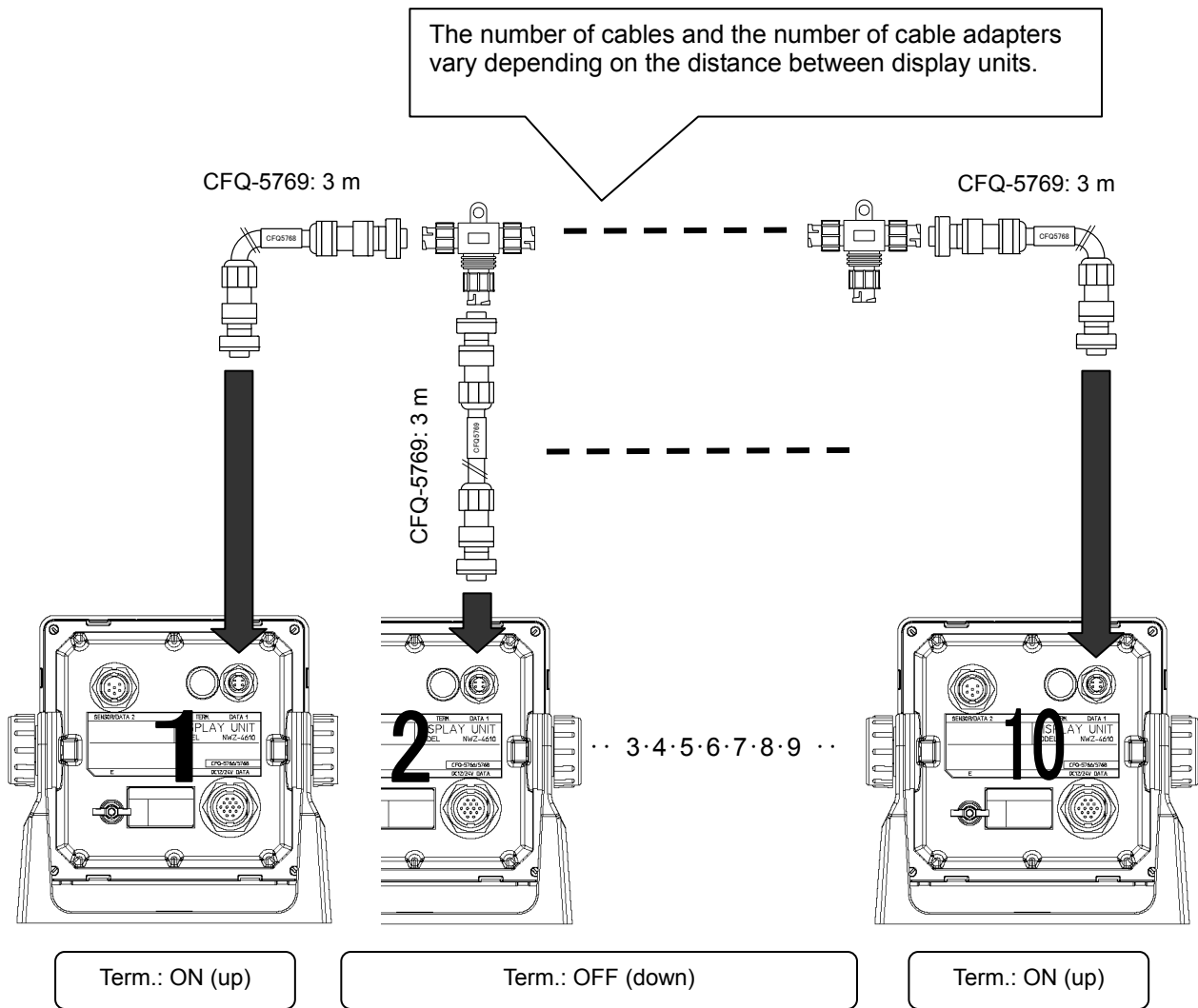

[To Group Dimmer Control]

The following shows an example of grouping 10 units (maximum number of connections) into 3 units, 3 units, and 4 units.

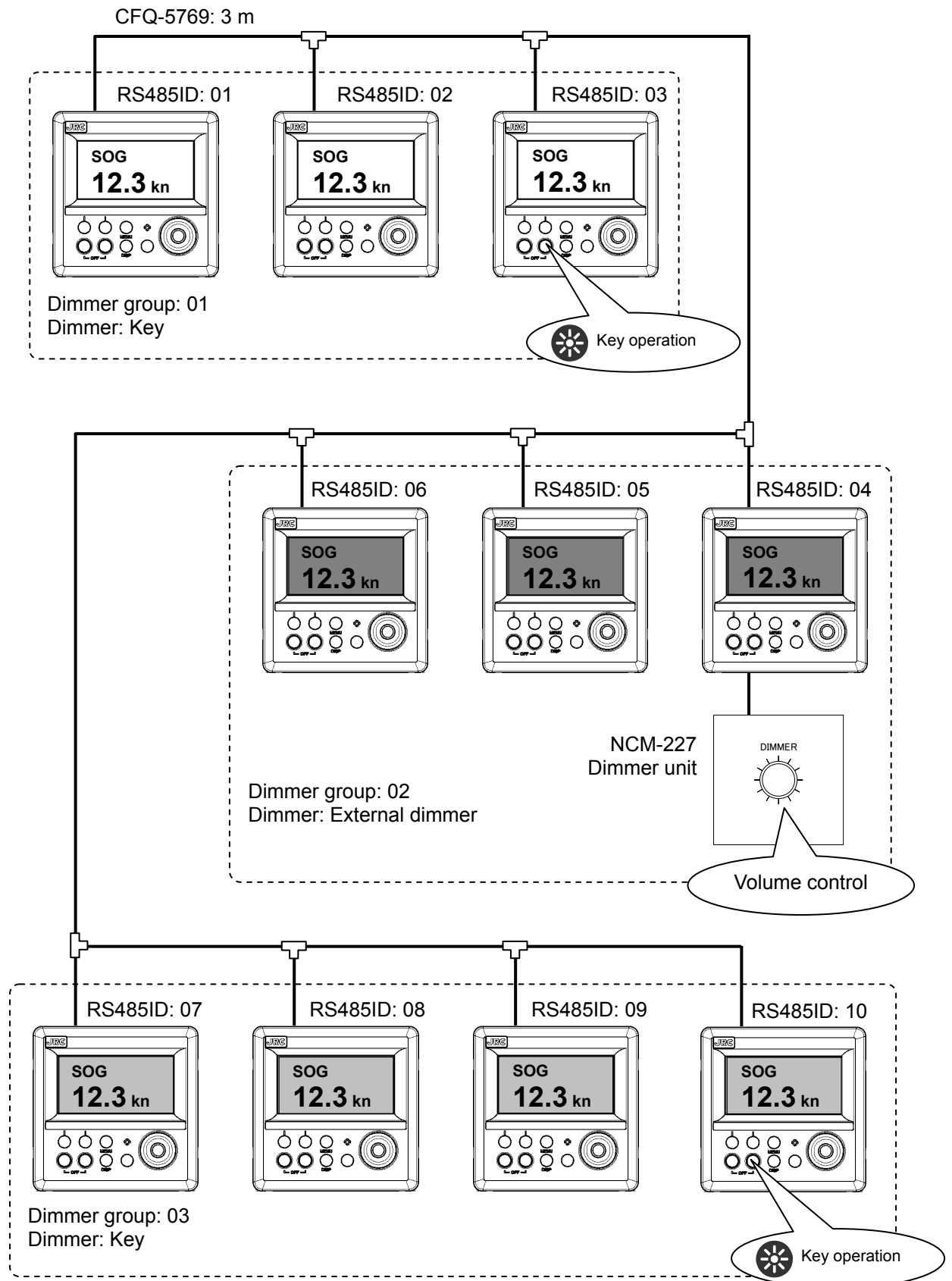

6.4.3 SENSOR/DATA2 Connector

In this display, the voltage supplied to the display is supplied to a receiver as it is. When you use receivers except JLR-4341/JLR-4340, set the power supply of a display to DC12V. Supply of 24V will damage a receiver.

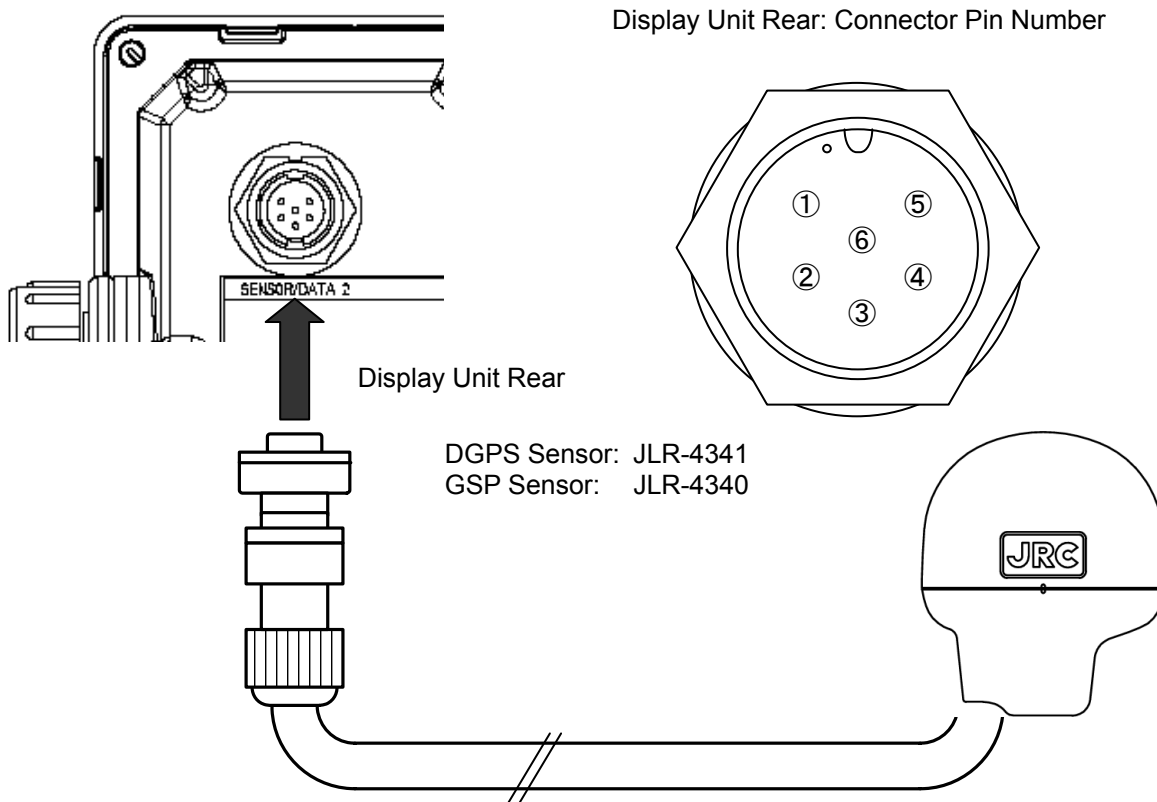

Terminal Number	Name	Explanation
1	Red	Power supply output
2	Black	
3	White	Serial transmission
4	Green	
5	Yellow	Serial transmission
6	Brown	Not Use

[To Extend the DGPS/GPS Sensor Cable]

- (1) For cable length of up to 15 m
Use the extension cable (CFQ-9000) for connection.

Waterproof treatment is required.
Refer to "Attention : Protection of connector against water" on the next page, please waterproof treatment.

DGPS sensor: JLR-4341
GPS sensor: JLR-4340

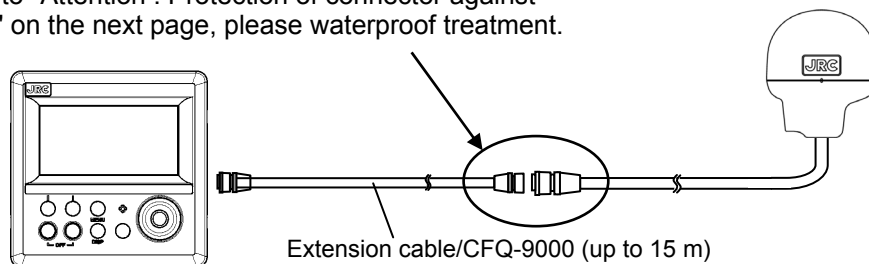

- (2) For cable length of more than 15 m
Use the junction box (NQE-7700A) for connection.

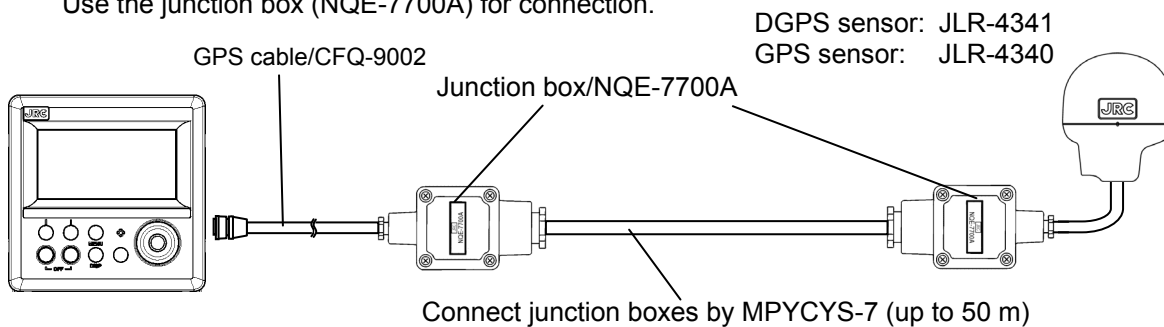

[Coaxial Cable Kit Connection]

When using a pre-existing coaxial cable, such as when switching from a JLR-6800, use a coaxial cable kit (NQD-4414).

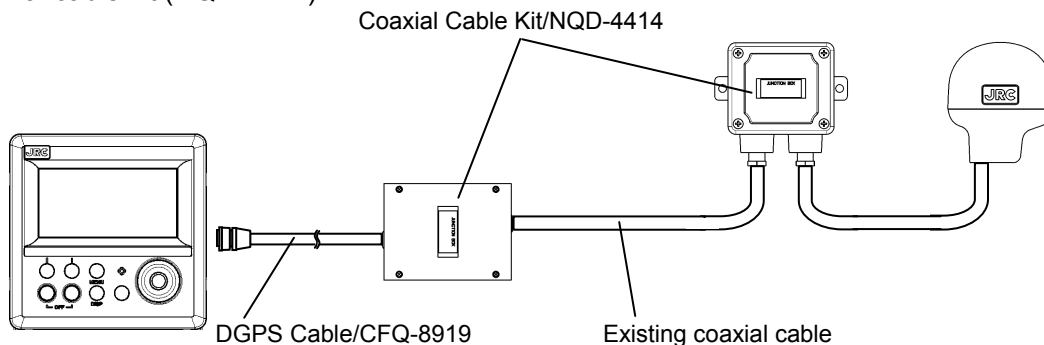

Attention : Protection of connector against water

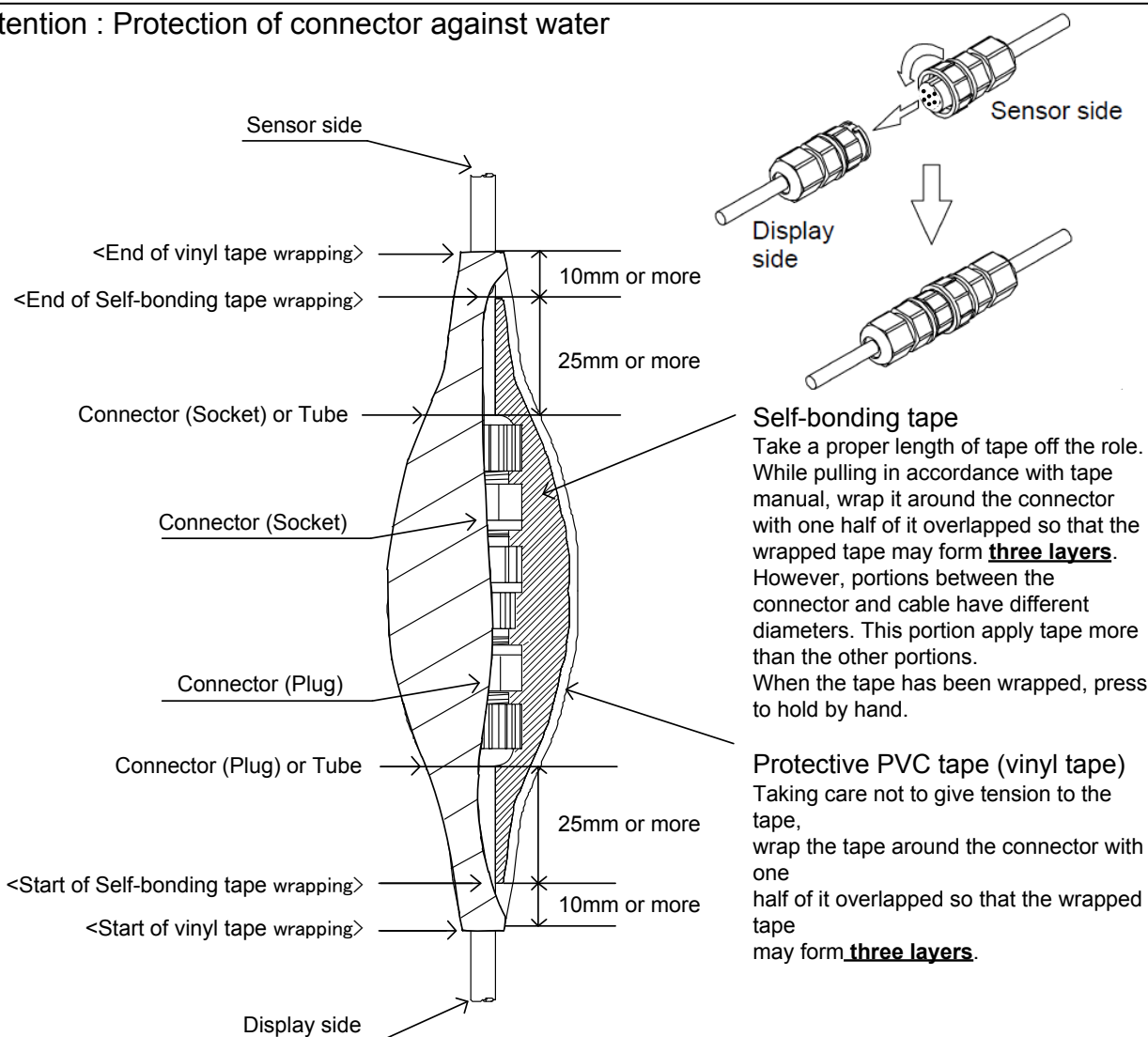

6.5 Optional Peripheral Connection

6.5.1 Sub-Display Connection

The external output of a main display is connected to the input of a sub display.

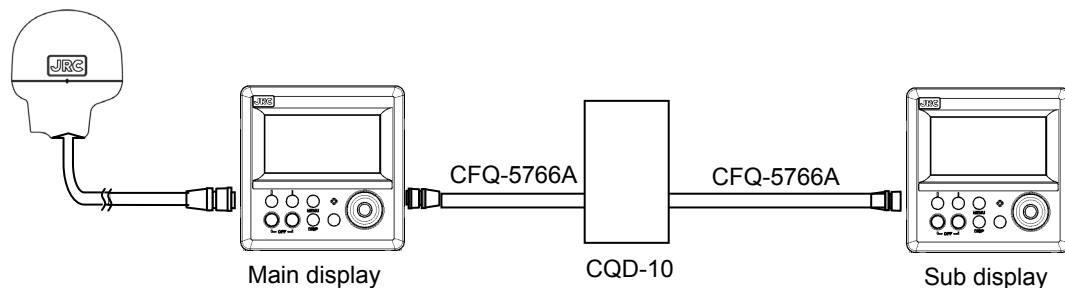

A junction box (CQD-10) is used for connection.

When you use it as a sub display, make a display type into a "sub".

The main and a sub can use it with every terminal. The example of a setting is shown below.

It is an example of a setting in the case of outputting from the data in / out 1 of a main display, and receiving with the data in / out 1 of a sub display.

	Main display	Sub display
Display type	Main	Sub
Connection port	Data in / out 1	Data in / out 1
Port TX/RX setup	TX	RX
Baud rate	9600	9600
Format	IEC	IEC
Sentence	GGA/RMC/VTG/GSA/GSV/ZDA/ MSS/DTM/ PJRCD,GP,3/PJRCD,GP,8/ PJRCD,GP,0/PJRCD,GP,2	-
Output cycle	1 second	-

6.5.2 Printer Connection

A printer unit (NKG-94) can be connected.

Please refer to Instruction Manual of NKG-94 for details.

6.5.3 Dimmer Unit Connection

The brightness of the backlight can be changed at a location away from the display unit by connecting the dimmer unit (NCM-227).

Connection example

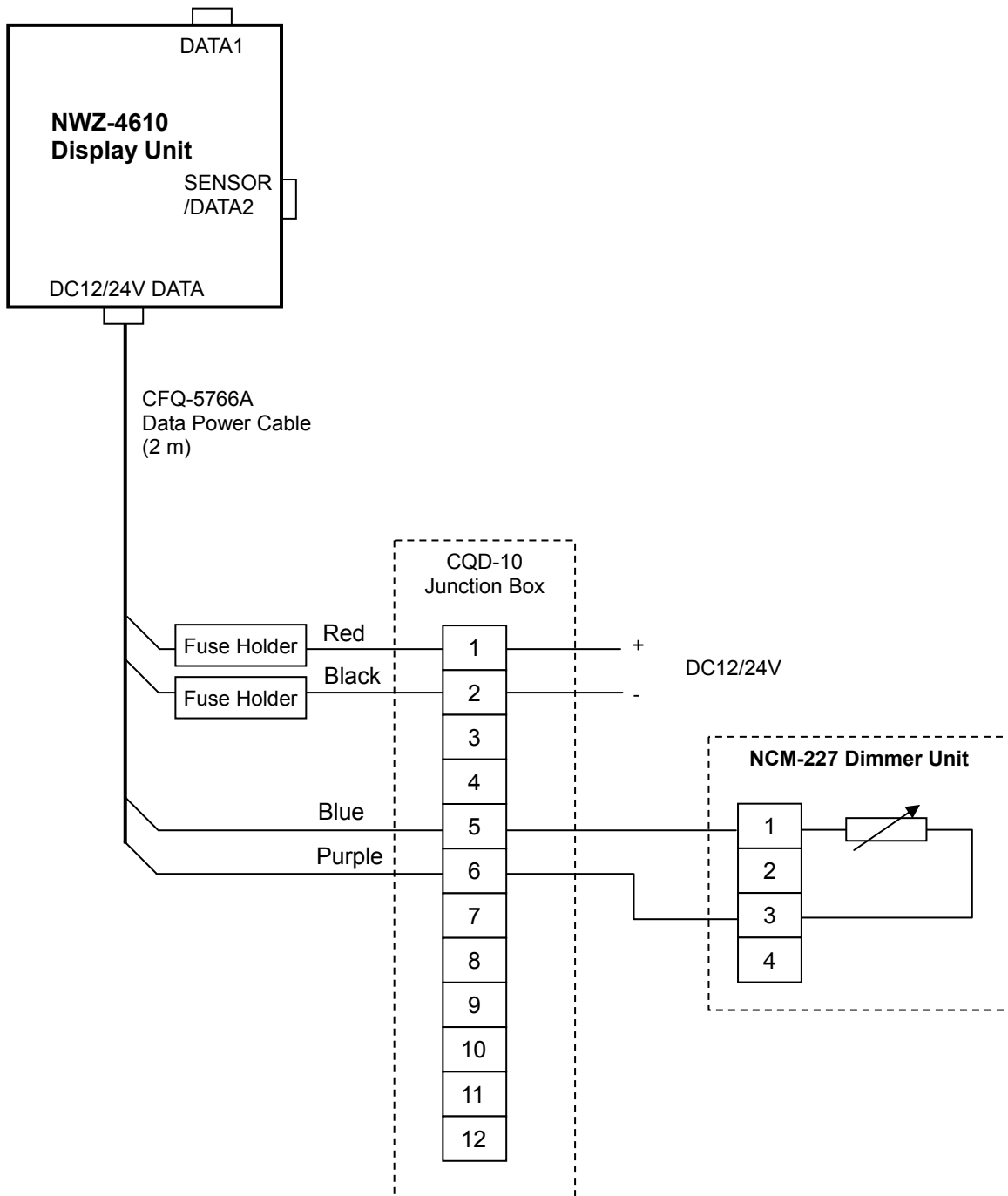

6.5.4 Junction Box Connection

CAUTION



The junction box rubber gasket (25 f gland side) fit $\phi 10$ mm - 20 mm cables.

• How to Mount the Junction Box on a Flat Surface

Securely mount the junction box on a given flat surface using self-tapping screws and flat washers as shown below.

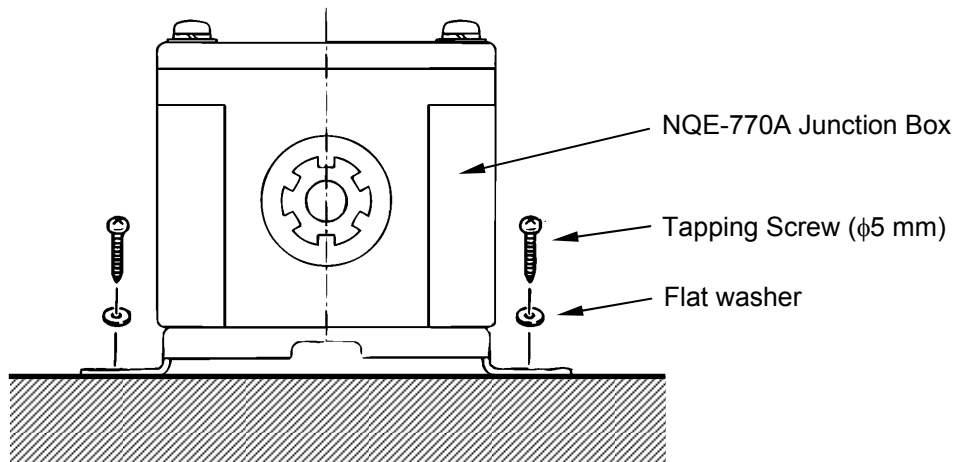

Attention

The self tapping screws and flat washers in the figure above are not included with this equipment.

• How to Mount the Junction Box on the Mast

Securely mount the junction box on the mast using the pole mounting kit (option: MPBP30608).

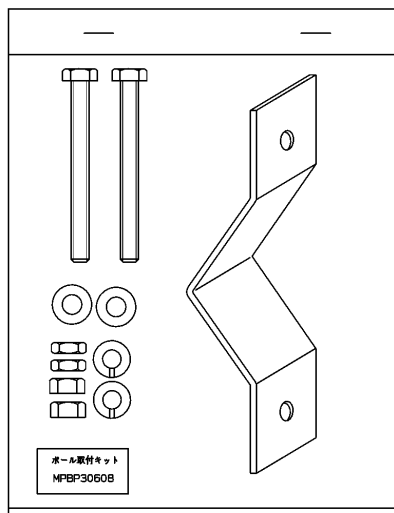

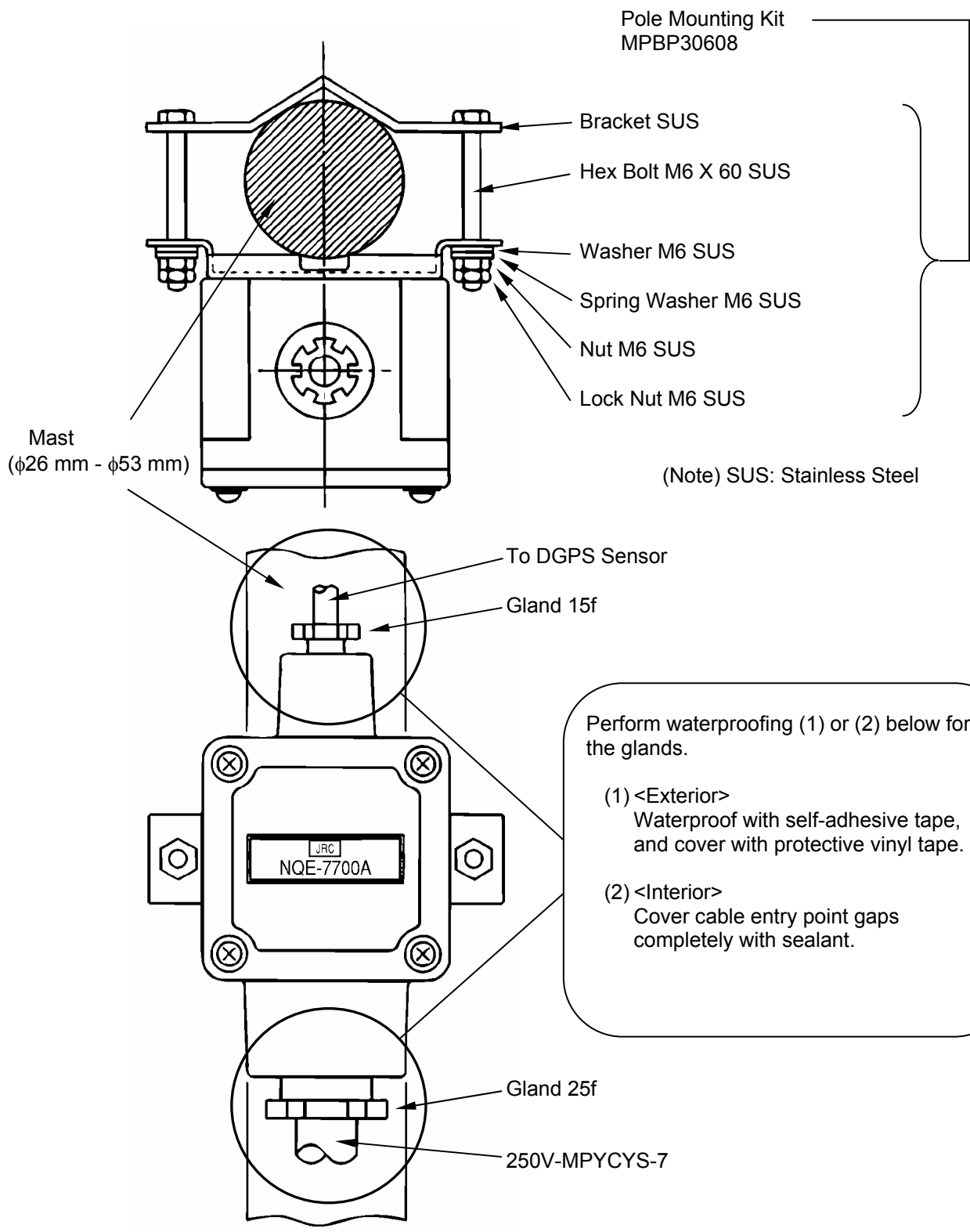

• **Internal Connection**

Connect the respective cables (cable from the DGPS sensor and extension cable) to the terminals provided in the junction box as shown in the following figure.

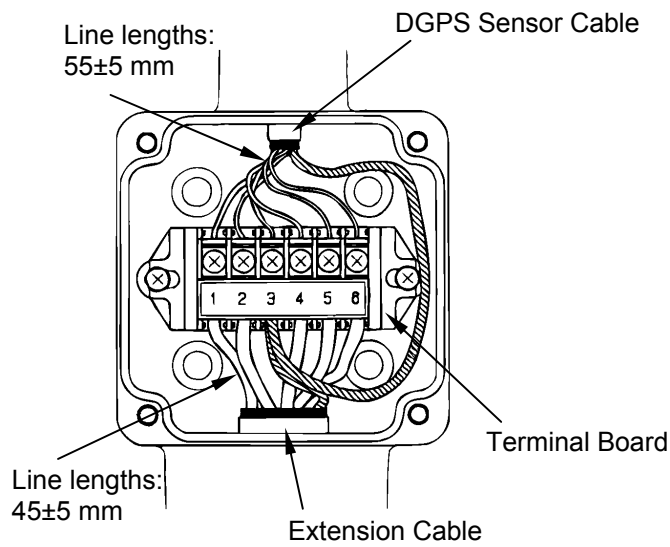

JLR-4341 DGPS Sensor Cable	Junction Box Terminal
Red	→ 1
Black	→ 2
White	→ 3
Green	→ 4
Yellow	→ 5
Brown	→ 6
Shield Line	→ 3

JLR-4340 GPS Sensor Cable	Junction Box Terminal
Red	→ 1
Black	→ 2
White	→ 3
Green	→ 4
Yellow	→ 5
Brown	→ 6
Blue	→ 3
Shield Line	→ 3
Orange (not used)	

6.5.5 Coaxial Cable Kit Connection

Please refer to the instructions included in the coaxial cable kit for details regarding coaxial cable kit connection.

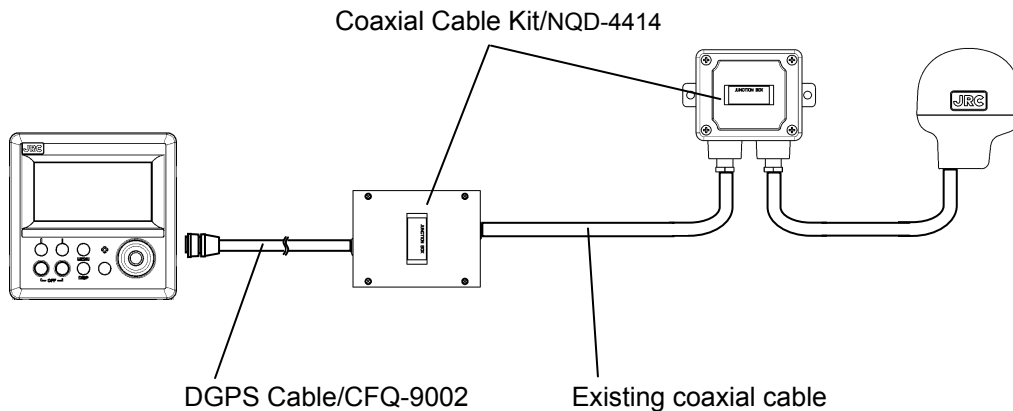

6.5.6 Output buffer (NQA-4351)

An output buffer unit can be distributed NMEA data to external unit (Up to 12 units)

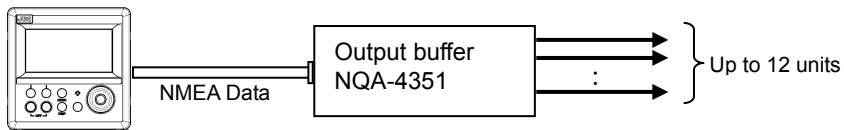

6.5.7 GPS Select Switch (Manual) (NCZ-1663)

A GPS select switch (NCZ-1663) can be connected to output buffer (NQA-4351) unit and switched GPS units manually.

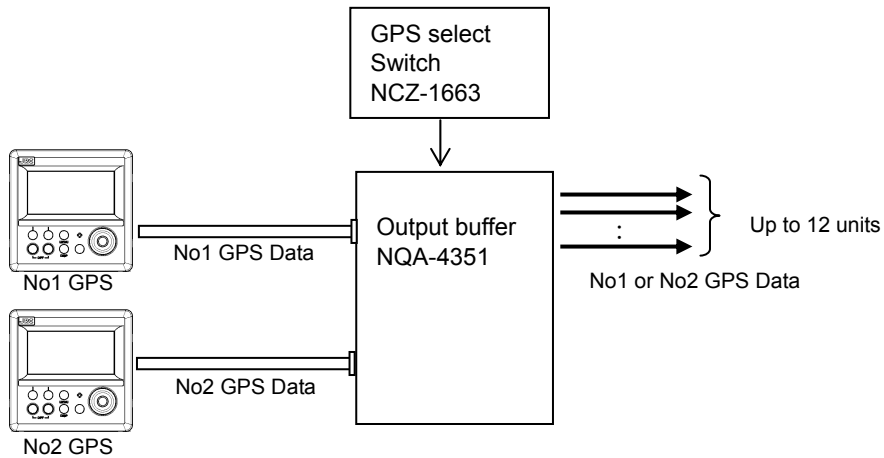

6.5.8 GPS Select Switch (Automatic) (NCZ-1537B)

A GPS select switch (NCZ-1537B) can be switched GPS units by control signal.

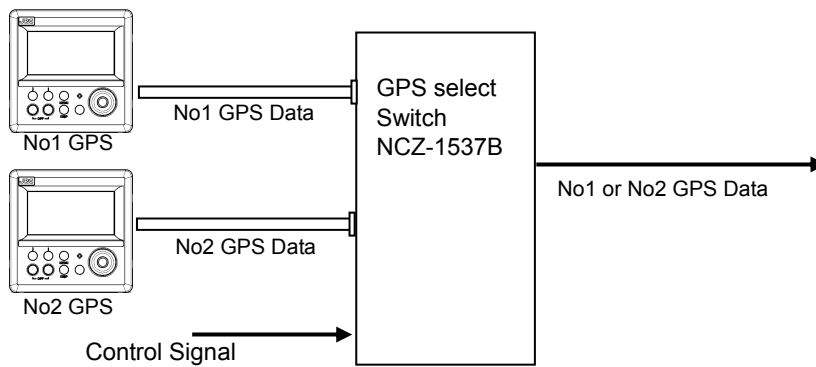

Section 7 After-Sales Service

7.1 Warranty

- Specific periods may vary based on our warranty policies, but the standard warranty period is **one year** from the date of purchase.

7.2 Repair parts stocking Period

- We keeps functional repair parts for this equipment (parts necessary for the functioning of this equipment) in stock for 10 years from the discontinuation of production.

7.3 When Requesting Service

When you think the equipment is not operating properly, please read "5.3 Troubleshooting" carefully, and inspect the equipment again. If the problem persists, stop using the equipment, and consult your dealer, or a JRC branch or affiliate.

- **Repairs during the warranty period**
Should a malfunction or failure occur when the equipment is operated according to the descriptions and instructions contained herein, it is repaired free of charge during the warranty period by JRC or another location specified by your dealer. However, any repair for failures resulting from misuse, negligence, or natural disasters, fire, or other Acts of God is charged.
- **Repairs after the warranty period**
Repairs to restore the proper equipment operation can be made at a specified rate with the user's consent. In this case, the equipment can either be sent to JRC or an affiliate, or on-ship repairs can be performed at a location specified by JRC or a sales affiliate. Repairs which cannot be performed on-board the ship needs to be performed in a repair plant.
- **Information that needs to be provided when requesting service**
 - Name, model, production date, and serial number
 - Detailed description of the malfunction (alert number, etc.)
 - Name, address, and telephone number of your company or organization

7.4 Recommended Checks and Inspection

Equipment performance is subject to degradation due to age and change of component conditions over time. In addition to your own routine check, additional inspection and maintenance is recommended. Please consult with your dealer or one of our local offices. Note that this inspection and maintenance is not free of charge.

If you have any other questions about after-sales service, please direct your inquiries to your dealer or nearest local office.

A list of branches is provided at the end of the "Contact List".

Section 8 Disposal



WARNING



When disposing of the used lithium battery, place insulating tape over the battery terminals, or otherwise insulate the battery. Failure to do so may result in heating, explosion, or fire due to a shorted battery.

8.1 Disposal of the Equipment

- Observe all rules and regulations of the local authorities when disposing of this equipment.

8.2 Disposal of Used Batteries

This equipment contains a lithium battery.

- When disposing of the used lithium battery, place insulating tape over the battery terminals, or otherwise insulate the battery. Dispose of the battery properly as directed by the local authorities. Consult your dealer, our sales office, or the local authorities for further details on disposal methods.

Section 9 Specification

9.1 NWZ-4610 Display Unit

9.1.1 Basic Specification

- Display Unit: 4.5 inch monochrome LCD 128 × 64 dots
- Backlight: White LED or orange LED
- Dimmer Levels: Bright, Medium, Dark, OFF
- Memory: Waypoints 1000 points (including event and MOB)
Track 2000 points
Route 20 routes
- Route Plan: 50 waypoints per one route
- Geodetic Datum: Selection among 47 geodetic datum
- Magnetic Variation: Automatic or manual selectable
- Navigation Calculation: Great circle or Rhumb line selectable
- Alert: Arrival, Anchor, XTD, No position fix, Speed, Trip, HDOP, DGPS
- Plot Function Scale: 0.125, 0.25, 0.5, 1.0, 2.0, 5.0, 10.0, 20.0, 50.0, 100.0NM
Interval: Time: 1sec ~ 60min (1sec) or Distance: 1 ~ 99.99NM (0.01NM) selectable
- Interface: Data 1 connector: Input or output 1 port (RS-485)
DC12/24V data connector: Power input
Serial input or output 3 ports (RS-422)
Contact input/output 1 port
Sensor/data 2 connector: 1 port for sensor
- Selectable unit: Distance/Speed NM/kn, km/km/h, mi/mi/h
Height m/ft/fm
- LORAN C: Latitude and Longitude can be converted into the Loran time difference.
- Display Language: English/Japanese/Norwegian/French/German/Italian/Spanish/
Vietnamese/Indonesian
- Power Supply Voltage: DC12/24V (+30%, -10%)
- Power consumption: Less than 8 W (JLR-7900 [JLR-4341 connection])
Less than 7 W (JLR-7600 [JLR-4340 connection])
Less than 4 W (NWZ-4610)
- Dimension: 142(W) × 142(H) × 92(D) mm
- Mass: Approximately 0.8 kg
- Software version: R54.02
- Viewing distance: 1m

9.1.2 Environment

- Operating Temperature: -15 °C to +55 °C
- Storage Temperature: -25 °C to +70 °C
- Vibration: IEC60945 ed.4 compliant
- EMC: IEC60945 ed.4 compliant
- Waterproofing: IP55

9.1.3 External Interface

(1) Serial Transmission

Channel	Specification	Input/Output	Output Format	Notes
DATA IN/OUT1	RS-422	Input/Output	NMEA, IEC, JRC	
DATA IN/OUT2	RS-422	Input/Output	NMEA, IEC, JRC	
DATA IN/OUT3	RS-422	Input/Output	NMEA, IEC, JRC	
RS-485	RS-485	Input/Output	NMEA, IEC	

(1-1) NMEA

- Specification: NMEA0183
- Version: Ver1.5, 2.1, 2.3, 4.0
- Bit Rate: 4800, 9600, 19200, 38400 bps
- Data Bit: 8 bits
- Parity: None
- Start Bit: 1 bit
- Stop Bit: 1 bit
- Output Sentence: GGA, RMC, GLL, VTG, GSA, GSV, DTM, GBS, GRS, GST, ZDA, GNS, MSS*, ALR, APB, BOD, BWC, BWR, RMB, XTE, ZDG, AAM, RTE, WPL, ACK, ALF, ALC, HBT
- Output Interval: 1s, 2s, 3s, 4s, 5s, 6s, 7s, 8s, 9s, OFF

*Function only available on JLR-7900

Note) Some combinations of output sentence, bit rates, and output intervals may not be possible.

(1-2) IEC

- Specification: IEC61162-1 ed.5

(1-3) JRC

- Specification: JRC
- Bit Rate: 1200 bps
- Data Bit: 8 bits
- Parity: None
- Start Bit: 1 bit
- Stop Bit: 2 bit

(2) Contact

Channel	Input/Output	Application
CONTACT1	Output	Alert, 200p/NM, 400p/NM
CONTACT2	Input	ACK, external dimmer

9.2 JLR-4341 DGPS Sensor

9.2.1 Basic Specification

(1)GPS Unit

- Reception Method : Multi channel 12ch + SBAS 1ch
- Reception Frequency : 1575.42MHz±1MHz (C/A code)
- Maximum Number of Tracked Satellites : 12 satellites
- Accuracy : 13m 2DRMS (HDOP≤4 SA off)
5m 2DRMS (Beacon selected)
7m 2DRMS (SBAS selected)
- SBAS : WAAS、MSAS、EGNOS
- Geodetic datum : Selection among 46 geodetic datum

(2)Beacon Unit

- Reception Frequency : 283.5~325kHz
- Selection of Beacon Station : Automatic or manual

(3)Power Supply

- Power Supply Voltage : DC12/24V (+30%,-10%)
- Power Consumption : less than 2.5W

(4)Dimensions and Mass

- Dimensions : ϕ 134mm×H155mm
- Mass : Approximately 1.7kg (Include Cable)

(5)Software version

- R40.0

9.2.2 Environment

- Operating Temperature : -25°C~+55°C
- Storage Temperature : -40°C~+70°C
- Vibration : IEC60945 ed.4 conformant
- EMC : IEC60945 ed.4 conformant
- Waterproofing : IP56

9.3 JLR-4340 GPS Sensor

9.3.1 Basic Specification

(1)GPS Unit

- Reception Method : Multi channel 12ch + SBAS 1ch
- Reception Frequency : 1575.42MHz±1MHz (C/A code)
- Maximum Number of Tracked Satellites : 12 satellites
- Accuracy : 13m 2DRMS (HDOP≤4 SA off)
7m 2DRMS (SBAS selected)
- SBAS : WAAS、MSAS、EGNOS
- Geodetic datum : Selection among 46 geodetic datum

(2)Power Supply

- Power Supply Voltage : DC12/24V (+30%,-10%)
- Power Consumption : less than 1.5W

(3)Dimension and Mass

- Dimensions : ϕ 108mm×H108mm
- Mass : Approximately 0.7Kg (Include Cable)

(4)Software version

- R39.0

9.3.2 Environment

- Operating Temperature : -25°C~+55°C
- Storage Temperature : -40°C~+70°C
- Vibration : IEC60945 ed.4 conformant
- EMC : IEC60945 ed.4 conformant
- Waterproofing : IP56

Appendix

Appendix1 List of Geodetic System

Screen Display	Setting		Geodetic System
W84	WGS-84	0	WGS-84
W72	WGS-72	1	WGS-72
TOY	JAPAN	2	Tokyo Datum
NAS	NAD27 USA	3	North American 1927 (USA)
NAS	NAD27 CAN	4	North American 1927 (Canada, Alaska)
EUR	EUROPE 50	5	Europe 1950 (Europe)
AUA	AUSTRALIA 66	6	Australian geodetic 1966 (Australia)
OGB	OSGB-36	7	Ordnance Survey of Great Britain (England)
008	NAD-83	8	NAD-83
ADI	ADI	11	Adindan (Ethiopia, Sudan)
ARF	ARF	12	ARC 1950 (Botswana)
AUG	AUG	13	Australian Geodetic 1984 (Australia)
BER	BER	14	Bermuda 1957 (Bermuda islands)
BOO	BOO	15	Bogota Observatory (Columbia)
CAI	CAI	16	Compo Inchauspe (Argentina)
CHI	CHI	17	Chatham 1971 (Chatham Islands)
CHU	CHU	18	Chua Astro (Paraguay)
COA	COA	19	Corrego Alegre (Brazil)
BAT	BAT	20	Djakarta (Batavia) (Sumatra)
EUR	EUR	21	European 1979 (Europe)
GEO	GEO	22	Geodetic Datum 1949 (New Zealand)
GUA	GUA	23	Guam 1963 (Guam)
024	024	24	Hayford 1910 (Finland)
HJO	HJO	25	Hjorsey 1955 (Iceland)
IND	IND	26	Indian (India, Nepal)
IRL	IRL	27	Ireland 1965 (Ireland)
KEA	KEA	28	Kertau 1948 (West Malaysia, Singapore)
LCF	LCF	29	L.C.5 Astro (Cayman Brac island)
LIB	LIB	30	Liberia 1964 (Liberia)
LUZ	LUZ	31	Luzon (Philippines)
MER	MER	32	Merchich (Morocco)
MIN	MIN	33	Minna (Cameroon)
NAH	NAH	34	Nahrwan (Oman)
NAP	NAP	35	Naparima, BWI (Trinidad and Tobago)
OEG	OEG	36	Old Egyptian (Egypt)
OHA	OHA	37	Old Hawaiian (Hawaiian Islands)
PLN	PLN	38	Pico de las Nieves (Canary Islands)
PRP	PRP	39	Provisional south American 1956 (South America)
HIT	HIT	40	Provisional south Chilean 1963 (South Chile)
PUR	PUR	41	Puerto Rico (Puerto Rico, Virgin Islands)
QUO	QUO	42	Qornoq (South Greenland)
043	043	43	RT90 (Sweden)
SAO	SAO	44	Santa Braz (San Miguel, Santa Maria islands)
SAN	SAN	45	South American 1969 (South America)
046	046	46	Southwest Base (Faial, Gracinao, Pico, San Jorge, Terceira islands)
TIL	TIL	47	Timbalai 1948 (Brunei, Malaysia)
SPK	SPK	48	SK-42 (Pulkovo 42)

Appendix2 List of standard terms, units and abbreviations

Term	Abbreviation
Acknowledge	ACK
Acquire, Acquisition	ACQ
Acquisition Zone	AZ
Adjust, Adjustment	ADJ
Aft	AFT
Alarm	ALARM
Altitude	ALT
Amplitude Modulation	AM
Anchor Watch	ANCH
Antenna	ANT
Anti Clutter Rain	RAIN
Anti Clutter Sea	SEA
April	APR
Audible	AUD
August	AUG
Automatic	AUTO
Automatic Frequency Control	AFC
Automatic Gain Control	AGC
Automatic Identification System	AIS
Automatic Radar Plotting Aid	ARPA
Autopilot	AP
Auxiliary System/Function	AUX
Available	AVAIL
Azimuth Indicator	AZI
Background	BKGND
Bearing	BRG
Bearing Waypoint To Waypoint	BWW
Bow Crossing Range	BCR
Bow Crossing Time	BCT
Brilliance	BRILL
Built in Test Equipment	BITE
Calibrate	CAL
Cancel	CNCL
Carried (for example, carried EBL origin)	C
Central Processing Unit	CPU
Centre	CENT

Term	Abbreviation
Change	CHG
Circularly Polarised	CP
Clear	CLR
Closest Point of Approach	CPA
Compact Disk Read Only Memory	CDROM
Consistent Common Reference Point	CCRP
Consistent Common Reference System	CCRS
Contrast	CONT
Coordinated Universal Time	UTC
Correction	CORR
Course	CRS
Course Over the Ground	COG
Course Through the Water	CTW
Course To Steer	CTS
Course Up	C UP
Cross Track Distance	XTD
Cursor	CURS
Dangerous Goods	DG
Date	DATE
Day	DAY
Dead Reckoning, Dead Reckoned Position	DR
December	DEC
Decrease	DECR
Delay	DELAY
Delete	DEL
Departure	DEP
Depth	DPTH
Destination	DEST
Deviation	DEV
Differential GLONASS	DGLONASS
Differential GNSS	DGNSS
Differential GPS	DGPS
Digital Selective Calling	DSC
Display	DISP
Distance	DIST

Term	Abbreviation
Distance Root Mean Square	DRMS
Distance To Go	DTG
Drift	DRIFT
Dropped (for example, dropped EBL origin)	D
East	E
Echo Reference	REF
Electronic Bearing Line	EBL
Electronic Chart Display and Information System	ECDIS
Electronic Chart System	ECS
Electronic Navigational Chart	ENC
Electronic Position Fixing System	EPFS
Electronic Range and Bearing Line	ERBL
Emergency Position Indicating Radio Beacon	EPIRB
Enhance	ENH
Enter	ENT
Equipment	EQUIP
Error	ERR
Estimated Position	EP
Estimated Time of Arrival	ETA
Estimated Time of Departure	ETD
European Geo-Stationary Navigational Overlay System	EGNOS
Event	EVENT
Exclusion Zone	EZ
External	EXT
F - Band (applies to Radar)	F-Band
February	FEB
Foreword	FWD
Fishing Vessel	FISH
Fix	FIX
Forward	FWD
Frequency	FREQ
Frequency Modulation	FM
Full	FULL
Gain	GAIN
Geographics	GEOG

Term	Abbreviation
Geometric Dilution Of Precision	GDOP
Global Maritime Distress and Safety System	GMDSS
Global Navigation Satellite System	GNSS
Global Orbiting Navigation Satellite System	GLONASS
Global Positioning System	GPS
Great Circle	GC
Grid	GRID
Ground	GND
Grounding Avoidance System	GAS
Group Repetition Interval	GRI
Guard Zone	GZ
Gyro	GYRO
Harmful Substances (applies to AIS)	HS
Head Up	H UP
Heading	HDG
Heading Control System	HCS
Heading Line	HL
High Frequency	HF
High Speed Craft	HSC
Horizontal Dilution Of Precision	HDOP
I - Band	I-Band
Identification	ID
In	IN
Increase	INCR
Indication	IND
Information	INFO
Infrared	INF RED
Initialisation	INIT
Input	INP
Input/Output	I/O
Integrated Bridge System	IBS
Integrated Navigation System	INS
Integrated Radio Communication System	IRCS
Interference Rejection	IR

Term	Abbreviation
Interswitch	ISW
Interval	INT
January	JAN
July	JUL
June	JUN
Label	LBL
Latitude	LAT
Latitude/Longitude	L/L
Leeway	LWY
Limit	LIM
Line Of Position	LOP
Log	LOG
Long Pulse	LP
Long Range	LR
Longitude	LON
Loran	LORAN
Lost Target	LOST TGT
Low Frequency	LF
Magnetic	MAG
Man Overboard	MOB
Manoeuvre	MVR
Manual	MAN
Map(s)	MAP
March	MAR
Maritime Mobile Services Identity number	MMSI
Maritime Pollutant (applies to AIS)	MP
Maritime Safety Information	MSI
Marker	MKR
Master	MSTR
Maximum	MAX
May	MAY
Medium Frequency	MF
Medium Pulse	MP
Menu	MENU
Minimum	MIN
Missing	MISSING
Mute	MUTE
Navigation	NAV

Term	Abbreviation
Night	NT
Normal	NORM
North	N
North Up	N UP
Not Less Than	NLT
Not More Than	NMT
Not Under Command	NUC
November	NOV
October	OCT
Off	OFF
Officer On Watch	OOW
Offset	OFFSET
On	ON
Out/Output	OUT
Own Ship	OS
Panel Illumination	PANEL
Parallel Index Line	PI
Past Positions	PAST POSN
Passenger Vessel	PASSV
Performance Monitor	MON
Permanent	PERM
Person Overboard	POB
Personal Identification Number	PIN
Pilot Vessel	PILOT
Port/Portside	PORT
Position	POSN
Positional Dilution Of Precision	PDOP
Power	PWR
Predicted	PRED
Predicted Area of Danger	PAD
Predicted Point of Collision	PPC
Pulse Length	PL
Pulse Modulation	PM
Pulse Repetition Frequency	PRF
Pulse Repetition Rate	PRR
Pulses Per Revolution	PPR
Racon	RACON
Radar	RADAR

Term	Abbreviation
Radar Plotting	RP
Radius	RAD
Rain	RAIN
Range	RNG
Range Rings	RR
Raster Chart Display System	RCDS
Raster Navigational Chart	RNC
Rate Of Turn	ROT
Real-time Kinematic	RTK
Receive	Rx RX
Receiver	RCDR
Receiver Autonomous Integrity Monitoring	RAIM
Reference	REF
Relative	REL
Relative Motion	RM
Revolutions per Minute	RPM
Rhumb Line	RL
Roll On/Roll Off Vessel	RoRo
Root Mean Square	RMS
Route	ROUTE
Safety Contour	SF CNT
Sailing Vessel	SAIL
Satellite	SAT
S-Band	S-BAND
Scan to Scan	SC/SC
Search And Rescue	SAR
Search And Rescue Transponder	SART
Search And Rescue Vessel	SARV
Select	SEL
September	SEP
Sequence	SEQ
Set (i.e., set and drift, or setting a value)	SET
Ship's Time	TIME
Short Pulse	SP
Signal to Noise Ratio	SNR
Simulation	SIM
Slave	SLAVE
South	S

Term	Abbreviation
Speed	SPD
Speed and Distance Measuring Equipment	SDME
Speed Over the Ground	SOG
Speed Through the Water	STW
Stabilized	STAB
Standby	STBY
Starboard/Starboard Side	STBD
Station	STN
Symbol(s)	SYM
Synchronised/Synchronous	SYNC
Target	TGT
Target Tracking	TT
Test	TEST
Time	TIME
Time Difference	TD
Time Dilution Of Precision	TDOP
Time Of Arrival	TOA
Time Of Departure	TOD
Time to CPA	TCPA
Time To Go	TTG
Time to Wheel Over Line	TWOL
Track	TRK
Track Control System	TCS
Tracking	TRKG
Trail(s)	TRAIL
Transmit and Receive	TXRX
Transceiver	TCVR
Transferred Line Of Position	TPL
Transmit	TX
Transmitter	TMTR ³
Transmitting Heading Device	THD
Transponder	TPR
Trial	TRIAL
Trigger Pulse	TRIG
True	T
True Motion	TM
Tune	TUNE
Ultrahigh Frequency	UHF
Uninterruptible Power Supply	UPS

Term	Abbreviation
Universal Time, Coordinated	UTC
Universal Transverse Mercator	UTM
Unstabilised	UNSTAB
Variable Range Marker	VRM
Variation	VAR
Vector	VECT
Very High Frequency	VHF
Very Low Frequency	VLF
Vessel Aground	GRND
Vessel at Anchor	ANCH
Vessel Constrained by Draught	VCD
Vessel Engaged in Diving Operations	DIVE
Vessel Engaged in Dredging or Underwater Operations	DRG
Vessel Engaged in Towing Operations	TOW
Vessel Not Under Command	NUC
Vessel Restricted in Manoeuvrability)	RIM
Vessel Traffic Service	VTs
Vessel Underway Using Engine	UWE
Video	VID

Term	Abbreviation
Visual Display Unit	VDU
Voyage	VOY
Voyage Data Recorder	VDR
Warning	WARNING
Water	WAT
Waypoint	WPT
Waypoint Closure Velocity	WCV
West	W
Wheel Over Line	WOL
Wheel Over Point	WOP
Wheel Over Time	WOT
World Geodetic System	WGS
X-Band	X-BAND

Appendix3 Default Value

Main menu	Sub menu	Sub menu	Default	
DISPLAY	LCD	CONTRAST	7	
		DIMMER -MAXIMUM-	11	
		DIMMER -TYPICAL-	7	
		DIMMER -MINIMUM-	3	
	CLICK SOUND		ON	
	DISPLAY SELECTION	DISPLAY1 DISPLAY AUTO SCREEN SOUND TIME		SPECIAL NAVIGATION INFO OFF OFF 1sec
		DISPLAY2 DISPLAY AUTO SCREEN SOUND TIME		GRAPHIC PLOT OFF OFF 1sec
		DISPLAY3 DISPLAY AUTO SCREEN SOUND TIME		GRAPHIC GPS OFF OFF 1sec
		DISPLAY4 DISPLAY AUTO SCREEN SOUND TIME		SPECIAL BEACON INFO OFF OFF 1sec
		DISPLAY5		OFF
		DISPLAY6		OFF
		BACK LIGHT		WHITE
PLOT	WAYPOINT MARK		○	
	EVENT MARK		□	
	TRACK PERIOD	OFF		
	TRACK TO ROUTE	TRACK PERIOD	TIME 1sec	
		ROUTE START/END	END	
WPT/ROUTE	WPT LIST	-		
	MAKE ROUTE/LIST	-		
	ROUTE START/END	LEG CHANGE	AUTO	
		DIRECTION	ORDER	
		SPEED SMOOTHING	OFF	
ROUTE		END		
SYSTEM	UNIT	DIST/SPD	NM,Kn	
		ANT HEIGHT	m	
	TIME DIFF		+0:00	
	DATE DISP	DATE DISP	DD MM,'YY HH:MM/	
	MAG CORR	DISPLAY	OFF	
		OUTPUT	OFF	
	LORAN C	LORAN C	OFF	
		GRI	4990	
		TD1	0	
		TD2	0	
		TD1 CORR	+0.0	
		TD2 CORR	+0.0	
	DATUM		W84	
	LANG.			ENGLISH

Main menu	Sub menu	Sub menu	Default
ALARM	SYSTEM		ON
		SOUND	ON
		LCD COLOR	OFF
	SPEED		OFF
	TRIP		OFF
	ARRIVAL/ANCHOR		OFF
	XTD		OFF
	DGPS		OFF
	HDOP		OVER
		OVER	4
		SOUND	OFF
		LCD COLOR	OFF
SENSOR	GPS MODE		AUTO
	FIX MODE		AUTO
	ELV MASK		5°
	HDOP		10
	SMOOTHING	POSITION	10sec
		SPEED	10sec
		COURSE	10sec
	RAIM ACCURACY		100
	INITIALIZATION	LATITUDE	35°00.0000'N
		LONGITUDE	139°00.0000'E
		HEIGHT	+10m
		DATE	2000/1/1
		TIMR	00:00:00
		SEND	-
	BEACON	STATION SELECT	AUTO
SBAS	SBAS SEARCH	AUTO	
	TYPE 0 INFO	OFF	
	RANGING	OFF	
BEACON	DISPLAY		ON

Main menu	Sub menu	Sub menu	Default
INTERFACE	DATA I/O	DATA IN/OUT1	NMEA
		NMEA	
		DATA IN/OUT	SEND
		VERSION	2.3
		SENTENCE	ACK,APB,DTM,GGA, RMB,RMC,VTG,ZDA
		BIT RATE	4800
		DATA IN/OUT2	NMEA
		NMEA	
		DATA IN/OUT	SEND
		VERSION	2.3
		SENTENCE	ACK,APB,DTM,GGA, RMB,RMC,VTG,ZDA
		BIT RATE	4800
		DATA IN/OUT3	NMEA
		NMEA	
		DATA IN/OUT	SEND
		VERSION	2.3
		SENTENCE	ACK,APB,DTM,GGA, RMB,RMC,VTG,ZDA
		BIT RATE	4800
		RS-485	
		NMEA	
		VERSION	2.3
		SENTENCE	None
	BIT RATE	115200	
CONTACT INPUT	ACK		
CONTACT OUTPUT	OFF		
	DIAGNOSIS		CONFIG OUT
MAIN/SUB			MAIN
RECEIVER No			1
DISPLAY TYPE			GPS
RS-485ID			1
DIMMER GROUP			1
DIMMER			EXT DIMMER
CCRP	BEAM		1.0m
	LENGTH		1.0m
	SENSOR X		+0m
	SENSOR Y		0m
	SENSOR Z		+0m
	CCRP X		+0m
	CCRP Y		0m
	CCRP Z		+0m

Appendix4 Setting Value memo

Normal menu

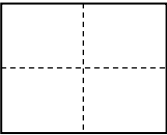
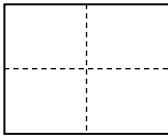
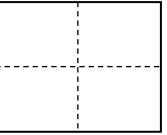
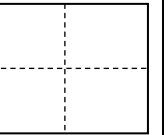
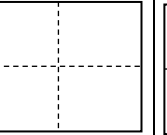
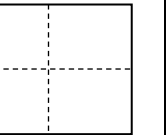
Main menu	Sub menu		Setting value															
DISPLAY	LCD		-															
	CONTRAST		1	2	3	4	5	6	7	8	9	10	11	12	13			
	DIMMER -MAXIMUM-		4	5	6	7	8	9	10	11	12	13						
	DIMMER -TYPICAL-		3	4	5	6	7	8	9	10	11	12						
	DIMMER -MINIMUM-		2	3	4	5	6	7	8	9	10	11						
	CLICK SOUND		ON/OFF															
	DISPLAY SELECTION		-															
	DISPLAY1	DISPLAY2	DISPLAY3	DISPLAY4	DISPLAY5	DISPLAY6												
	DISPLAY1 DISPLAY2 DISPLAY3 DISPLAY4 GRAPHIC SPECIAL OFF	DISPLAY1 DISPLAY2 DISPLAY3 DISPLAY4 GRAPHIC SPECIAL OFF	DISPLAY1 DISPLAY2 DISPLAY3 DISPLAY4 GRAPHIC SPECIAL OFF	DISPLAY1 DISPLAY2 DISPLAY3 DISPLAY4 GRAPHIC SPECIAL OFF	DISPLAY1 DISPLAY2 DISPLAY3 DISPLAY4 GRAPHIC SPECIAL OFF	DISPLAY1 DISPLAY2 DISPLAY3 DISPLAY4 GRAPHIC SPECIAL OFF												
																		
	DISPLAY MODE NORMAL/ SPECIAL1/ SPECIAL2/ AUTO RANGE AUTO SCREEN ON/OFF SOUND ON/OFF TIME sec	DISPLAY MODE NORMAL/ SPECIAL1/ SPECIAL2/ AUTO RANGE AUTO SCREEN ON/OFF SOUND ON/OFF TIME sec	DISPLAY MODE NORMAL/ SPECIAL1/ SPECIAL2/ AUTO RANGE AUTO SCREEN ON/OFF SOUND ON/OFF TIME sec	DISPLAY MODE NORMAL/ SPECIAL1/ SPECIAL2/ AUTO RANGE AUTO SCREEN ON/OFF SOUND ON/OFF TIME sec	DISPLAY MODE NORMAL/ SPECIAL1/ SPECIAL2/ AUTO RANGE AUTO SCREEN ON/OFF SOUND ON/OFF TIME sec	DISPLAY MODE NORMAL/ SPECIAL1/ SPECIAL2/ AUTO RANGE AUTO SCREEN ON/OFF SOUND ON/OFF TIME sec												
	BACK LIGHT		WHITE/ORANGE															
PLOT	WAYPOINT MARK																	
	EVENT MARK																	
	TRACK PERIOD		OFF	TIME	DISTANCE													
	TRACK TO ROUTE		OFF	TIME	DISTANCE													
SYSTEM	UNIT		-															
	DIST/SPD		NM, kn / km, km/h / mi, mi/h / m, m/s															
	ANT HEIGHT		m/ft/fm															
	TIME DIFF		:															
	DATE DISP		-															
	DATE DISP		DD MMM, 'YY HH:MM / MMM DD, 'YY HH:MM / YY-MMM-DD HH:MM															
	MAG CORR																	
	DISPLAY		OFF/AUTO/ MANUAL(E / W °)															
	OUTPUT		OFF/AUTO/ MANUAL(E / W °)															
	LORAN C		-															
	LORAN C		ON/OFF															
	GRI																	
	TD1																	
	TD2																	
	TD1 CORR																	
	TD2 CORR																	
	DATUM																	

Main menu	Sub menu	Setting value
LANG.	LANG.	English/Japanese/Norwegian/French/German/Italian/Spanish/Vietnamese/Indonesian
ALARM	SYSTEM	ON/OFF
	SOUND	ON/OFF
	LCD COLOR	ON/OFF
	SPEED	OVER/UNDER/IN RANGE/OUT RANGE
	OVER UNDER MAXIMUM MINIMUM	
	SOUND	ON/OFF
	LCD COLOR	ON/OFF
	TRIP	OVER/OFF
	OVER	
	SOUND	ON/OFF
	LCD COLOR	ON/OFF
	ARRIVAL/ANCHOR	ARRIVAL/ANCHOR/OFF
	SOUND	ON/OFF
	LCD COLOR	ON/OFF
	XTD	XTD/OFF
	SOUND	ON/OFF
	LCD COLOR	ON/OFF
	DGPS	ON→OFF/OFF→ON/OFF↔ON/OFF
	SOUND	ON/OFF
	HDOP	OVER/OFF
	OVER	
	SOUND	ON/OFF
	LCD COLOR	ON/OFF







Maintenance menu

Main menu	Sub menu	Setting value
BEACON		ON/OFF
INTERFACE	DATA I/O	—
	DATA IN/OUT1	—
	NMEA	—
	DATA IN/OUT	SEND/RECEIVE
	VERSION	1.5/2.1/2.3/4.0
	SENTENCE	DATA IN/OUT1 SENTENCE
	BIT RATE	4800/9600/19200/38400
	IEC	—
	DATA IN/OUT	SEND/RECEIVE
	SENTENCE	DATA IN/OUT1 SENTENCE
	BIT RATE	4800/9600/19200/38400
	JRC	
	INTERVAL	OFF/4s

Main menu	Sub menu	Setting value
	DATA IN/OUT2	—
	NMEA	—
	DATA IN/OUT	SEND/RECEIVE
	VERSION	1.5/2.1/2.3/4.0
	SENTENCE	DATA IN/OUT2 SENTENCE
	BIT RATE	4800/9600/19200/38400
	IEC	—
	DATA IN/OUT	SEND/RECEIVE
	SENTENCE	DATA IN?OUT2 SENTENCE
	BIT RATE	4800/9600/19200/38400
	JRC	—
	INTERVAL	OFF/4s
	ROUTE WPT	—
	VERSION	1.5/2.1/2.3/4.0/JRC
	BIT RATE	4800/9600/19200/38400
	OUTPUT DATA	ALL WAYPOINT/ALL ROUTE/ALL WAYPOINT+ROUTE/ ALL TRACK
	DATA IN/OUT3	—
	NMEA	—
	DATA IN/OUT	SEND/RECEIVE
	VERSION	1.5/2.1/2.3/4.0
	SENTENCE	DATA IN/OUT3 SENTENCE
	BIT RATE	4800/9600/19200/38400
	IEC	—
	DATA IN/OUT	SEND/RECEIVE
	SENTENCE	DATA IN/OUT3 SENTENCE
	BIT RATE	4800/9600/19200/38400
	JRC	—
	INTERVAL	OFF/4s
	ROUTE WPT	—
	BIT RATE	4800/9600/19200/38400

Main menu	Sub menu	Setting value
	RS-485	—
	NMEA	—
	VERSION	1.5/2.1/2.3/4.0
	SENTENCE	RS-485 SENTENCE
	BIT RATE	38400/57600/76800/115200
	IEC	—
	SENTENCE	RS-485 SENTENCE
	BIT RATE	38400/57600/76800/115200
	CONTACT INPUT	DIMMER/ACK
	CONTACT OUTPUT	200PULSE/NM / 400PULSE/NM/ / ALARM/ OFF
	DIAGNOSIS	—
MAINTENANCE	INPUT DATA	—
	DIAGNOSIS	—
	ERROR LOG	—
	SOFT VERSION	—
	DISPLAY VER	—
	APP VER	
	SERIAL NUMBER	
	BARCORD	
	SENSOR VERSION	—
	APP VER	
	SERIAL NUMBER	
	BARCORD	
MAIN/SUB		MAIN/SUB
RECEIVER No.		1/2
DISPLAY TYPE		MID/LOG/GPS/OFF
RS-485ID		1 2 3 4 5 6 7 8 9 10
DIMMER GROUP		1 2 3 4 5 6 7 8 9 10
DIMMER		EXT DIMMER/KEY
CCRP	BEAM	
	LENGTH	
	SENSOR X	
	SENSOR Y	
	SENSOR Z	
	CCRP X	
	CCRP Y	
	CCRP Z	

Appendix5 List of Symbols

Symbol name	Symbol graphic
Own ship - simplified symbol	Double circle 
Past track	Small filled circle 
Waypoint	Circle 
Route	Long-dashed line 
Event	Square with diagonal line 
User cursor	Cross line 

Appendix6 Compass Safe Distance

No	Name	Model	Compass Safe Distance [m]	
			Standard	Steering
1	AC Power Supply	NBG-320	0.3	0.2
2	AC Power Supply	NBD-577C	0.9	0.6
3	Printer	NGK-94	0.7	0.4
4	Printer	NKG-104	0.8	0.5
5	Select Switch	NCZ-777	0.2	0.1
6	Select Switch	NCZ-1663	0.1	0.1
7	Select Switch	NCZ-1537A	0.2	0.1
8	Junction Box	NQE-7700A	0.2	0.1
9	Output Buffer	NQA-4251A	0.1	0.1
10	Output Buffer	NQA-4351	0.1	0.1
11	Junction Box (note 1)	NQD-4410	0.2	0.1
12	Junction Box (note 1)	NQD-4411	0.2	0.1
13	Junction Box	CQD-10	0.3	0.2

note 1) Coaxial Cable Kit NQD-4414: consisting of NQD-4410 and NQD-4411

有毒有害物质或元素的名称及含量
(Names & Content of toxic and hazardous substances or elements)

形式名(Type): JLR-7900/7600

名称(Name): GPS Navigator

部件名称 (Part name)	有毒有害物质或元素 (Toxic and Hazardous Substances and Elements)					
	铅 (Pb)	汞 (Hg)	镉 (Cd)	六价铬 (Cr ⁶⁺)	多溴联苯 (PBB)	多溴二苯醚 (PBDE)
GPS接收器 (Antenna)	×	○	×	×	×	×
船内装置(Inboard Unit) ·显示装置(Display Unit)	×	×	×	×	×	×
外部设备(Peripherals) ·选择(Options) ·电线类(Cables) ·手册(Documentts)	×	○	×	×	×	×
<p>○: 表示该有毒有害物质在该部件所有均质材料中的含量均在SJ/T11363-2006 标准规定的限量要求以下。 (Indicates that this toxic, or hazardous substance contained in all of the homogeneous materials for this part is below the requirement in SJ/T11363-2006.)</p> <p>×: 表示该有毒有害物质至少在该部件的某一均质材料中的含量超出SJ/T11363-2006 标准规定的限量要求。 (Indicates that this toxic or hazardous substance contained in at least one of the homogeneous materials used for this part is above the limit requirement in SJ/T 11363-2006.)</p>						

アスベストは使用しておりません
Not use the asbestos

For further information, contact:



Since 1915

Japan Radio Co., Ltd.

URL Head office : <http://www.jrc.co.jp/eng/>

Marine Service Department

1-7-32 Tatsumi, Koto-ku, Tokyo 135-0053, Japan

e-mail : tmsc@jrc.co.jp

One-call : +81-50-3786-9201

ISO 9001, ISO 14001 Certified